

USP – Universidade de São Paulo

Física Experimental C - Laboratório

# Difração de Raio X

João Kogler

PSI / EP USP

Versão 2024



# Etapas

- **Sessão no laboratório (presencial)**
  - Adquirir dados de difração
    - Parte 1
      - experimento de Bragg a 35 kV, 30 kV e 25 kV
    - Parte 2
      - Determinação da constante de Planck
  - Calcular e analisar resultados
  - Elaborar o relatório e entregar (daqui a 3 dias)
    - Formato pdf, através de email para: [kogler@usp.br](mailto:kogler@usp.br)



## Difratômetro de Raio X – no Laboratório (presencial)

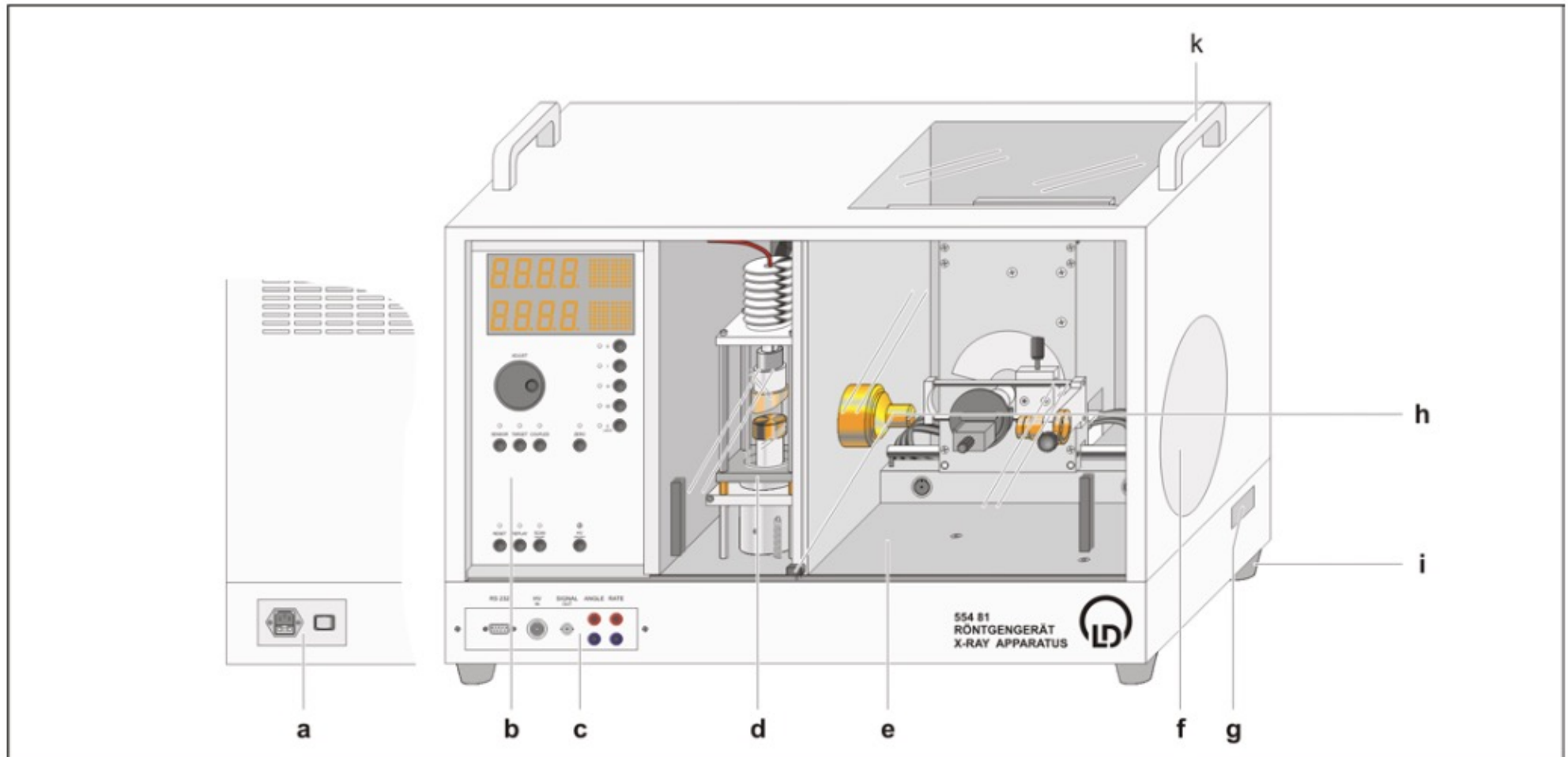

**a** Campo de conexão à rede  
**b** Campo de comando  
**c** Campo de conexão

**d** Câmara do tubo  
(com tubo de raios X)  
**e** Câmara de experiências  
(aqui com goniômetro)

**f** Tela fluorescente  
**g** Canal livre  
**h** Tecla de bloqueio

**i** Pés  
**k** Alças de transporte

# O Difratoômetro de Raio-X

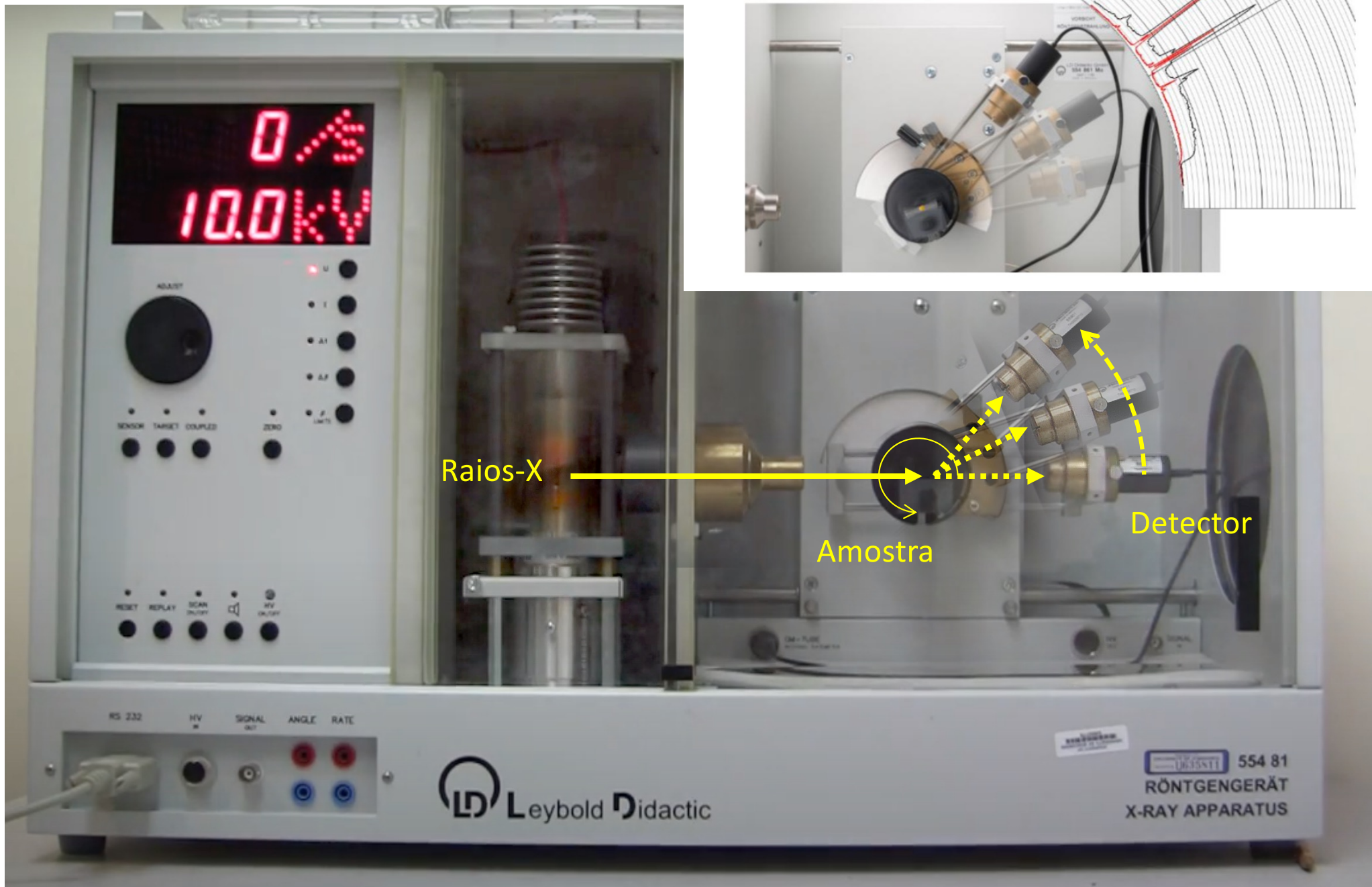

# O Difratorômetro de Raio-X

# contagens / unidade de tempo

Picos de radiação característica

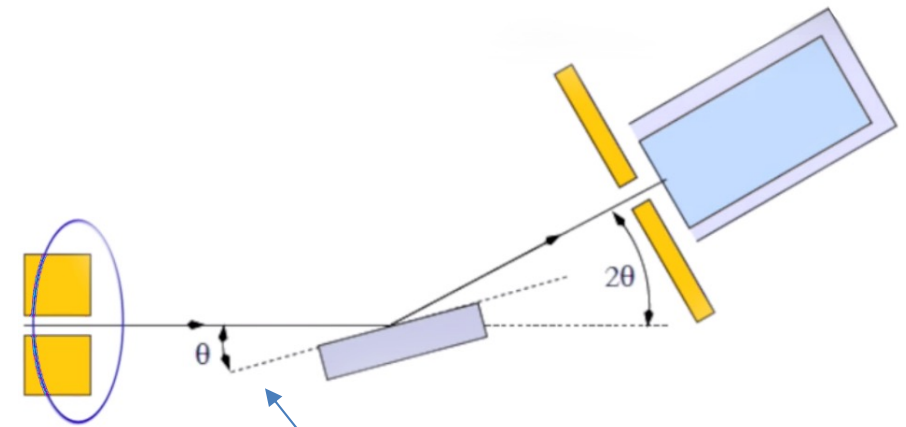
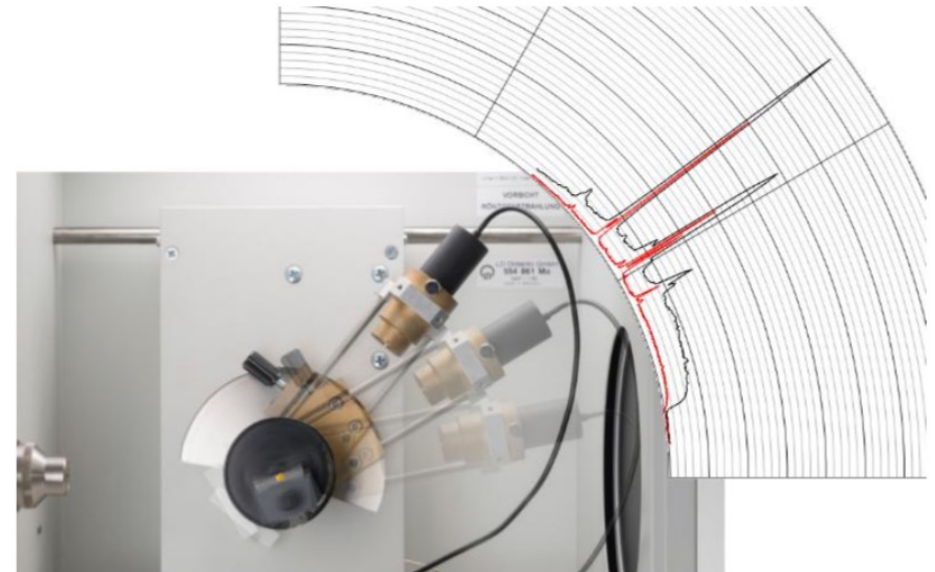
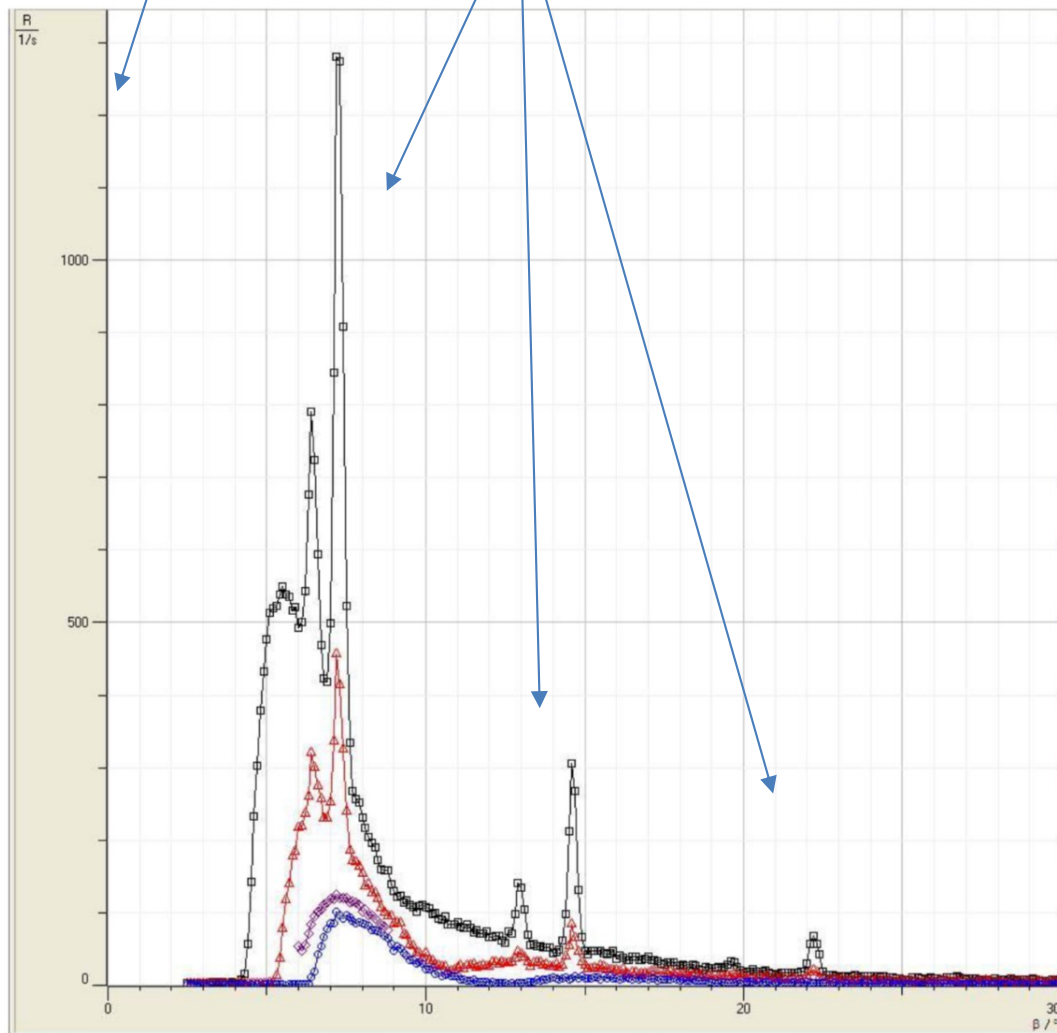

Ângulo de incidência

## Tubo de raio X

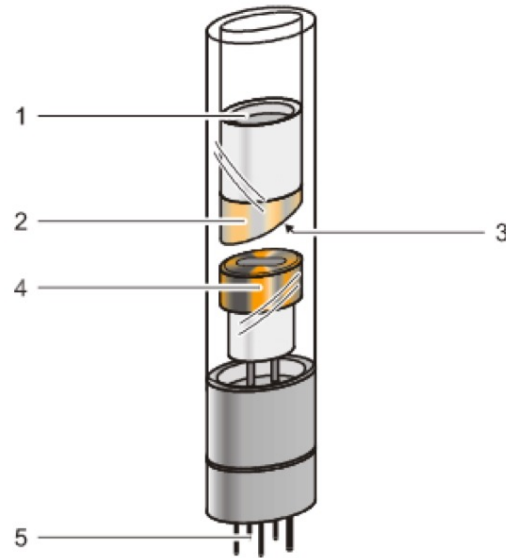
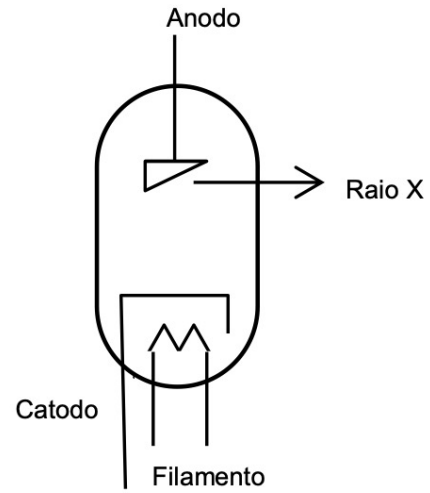

1 – Conexão com o dissipador de calor

2 – Bloco de cobre de suporte

3 – Anodo de Molibdênio

4 – Catodo aquecido

5 – Pinos de conexão ao soquete

## Emissões de raio X

Emissões de pico ('fluorescências')  
Radiação de decaimento

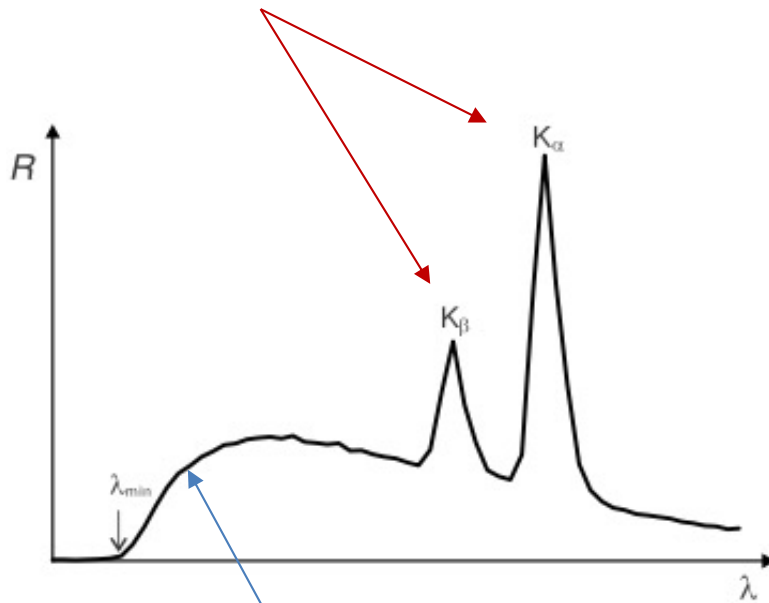

Emissão de fundo (background)  
'Bremsstrahlung'  
(radiação de freamento)

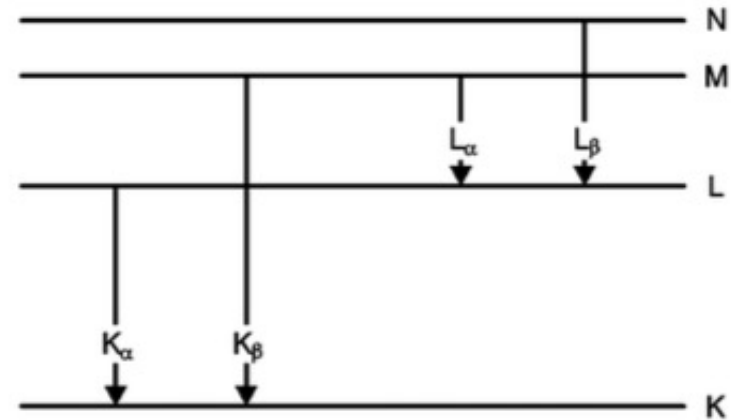

Emissões de pico ('fluorescências')  
Radiação de decaimento



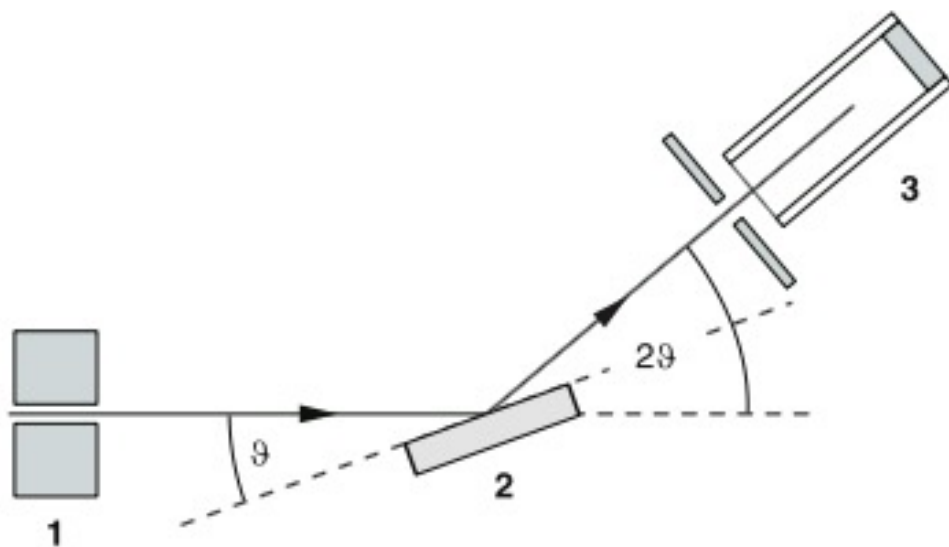

1. Fenda colimadora
2. Cristal
3. Detector de radiação ionizante



Goniômetro com Detector de Feixe



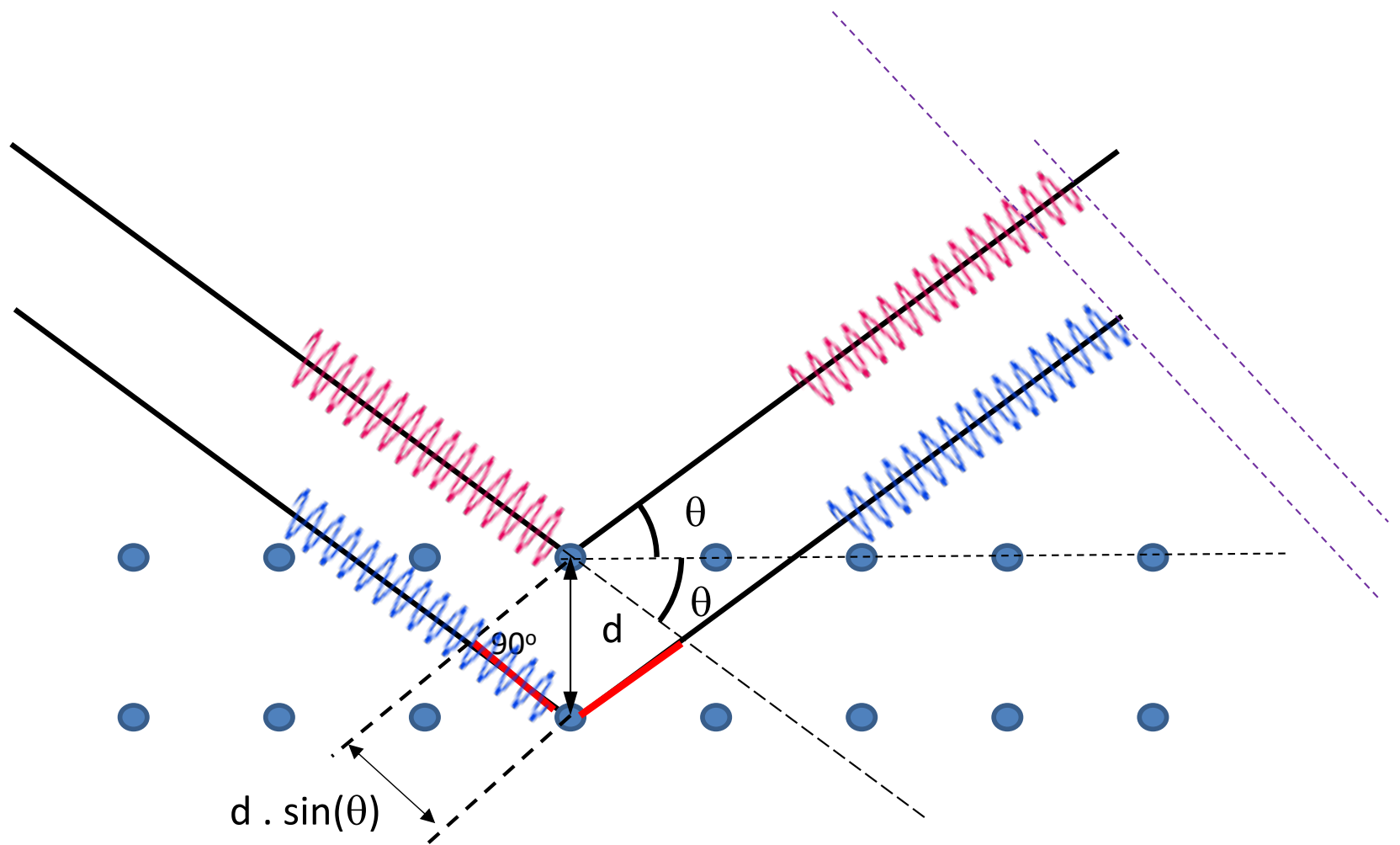

Lei de Bragg  $n\lambda = 2 \cdot d \sin(\theta)$

1. Fenda colimadora
2. Cristal
3. Detector de radiação ionizante

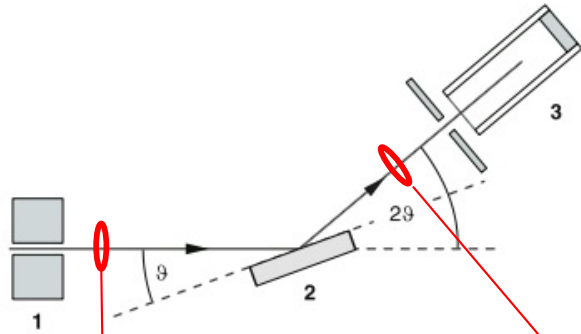

Com a difração

Sem a difração

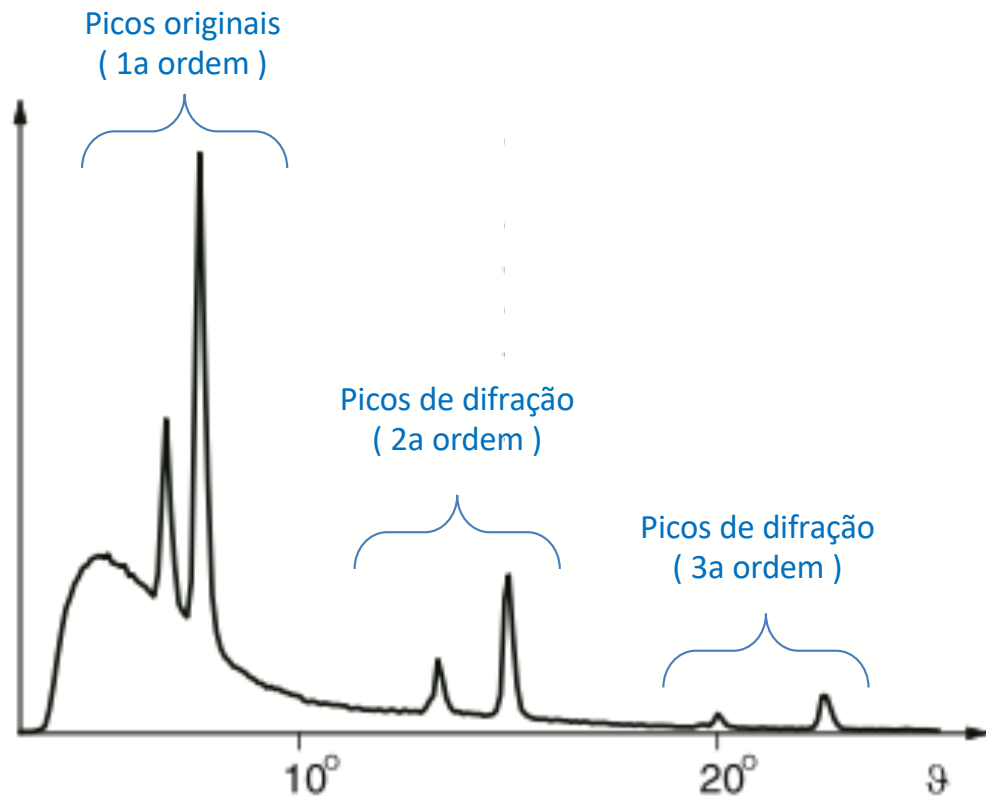
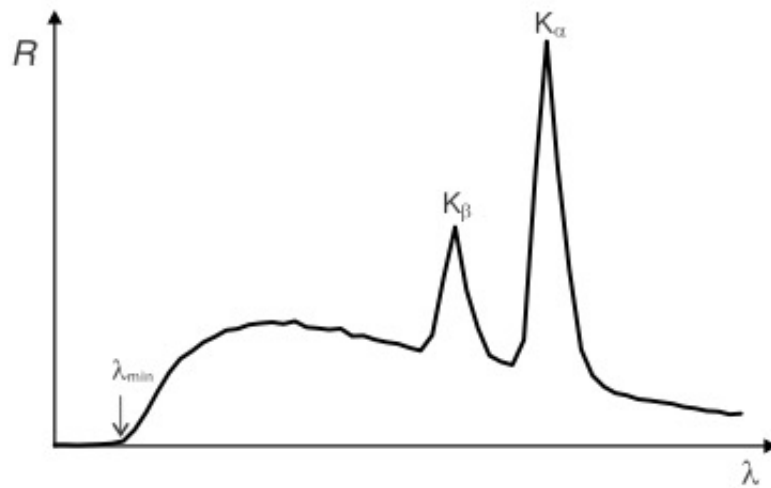

# Software *X ray apparatus*

- **Disponível só no lab**
  - Procure no desktop do computador o ícone do software **X\_ray\_app** e clique nele e abra o programa



# Aquisição dos dados

Primeiramente, abra o programa X  
ray apparatus no computador





Figura 1 – painel de abertura do programa *X ray apparatus*



Figura 2 – Barra de ferramentas do programa *Xray apparatus*

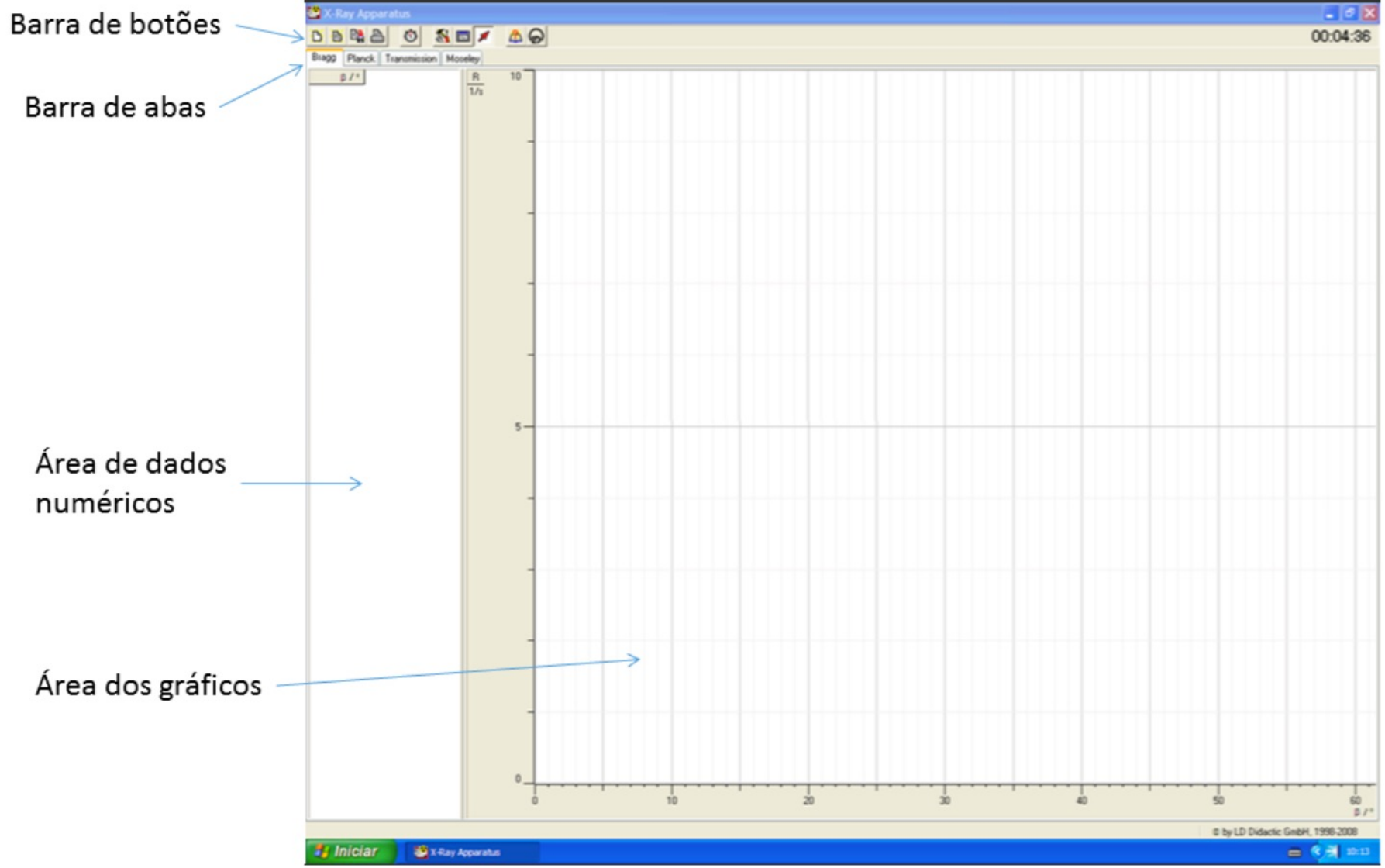

Bragg Planck Transmission Moseley

$\beta / ^\circ$

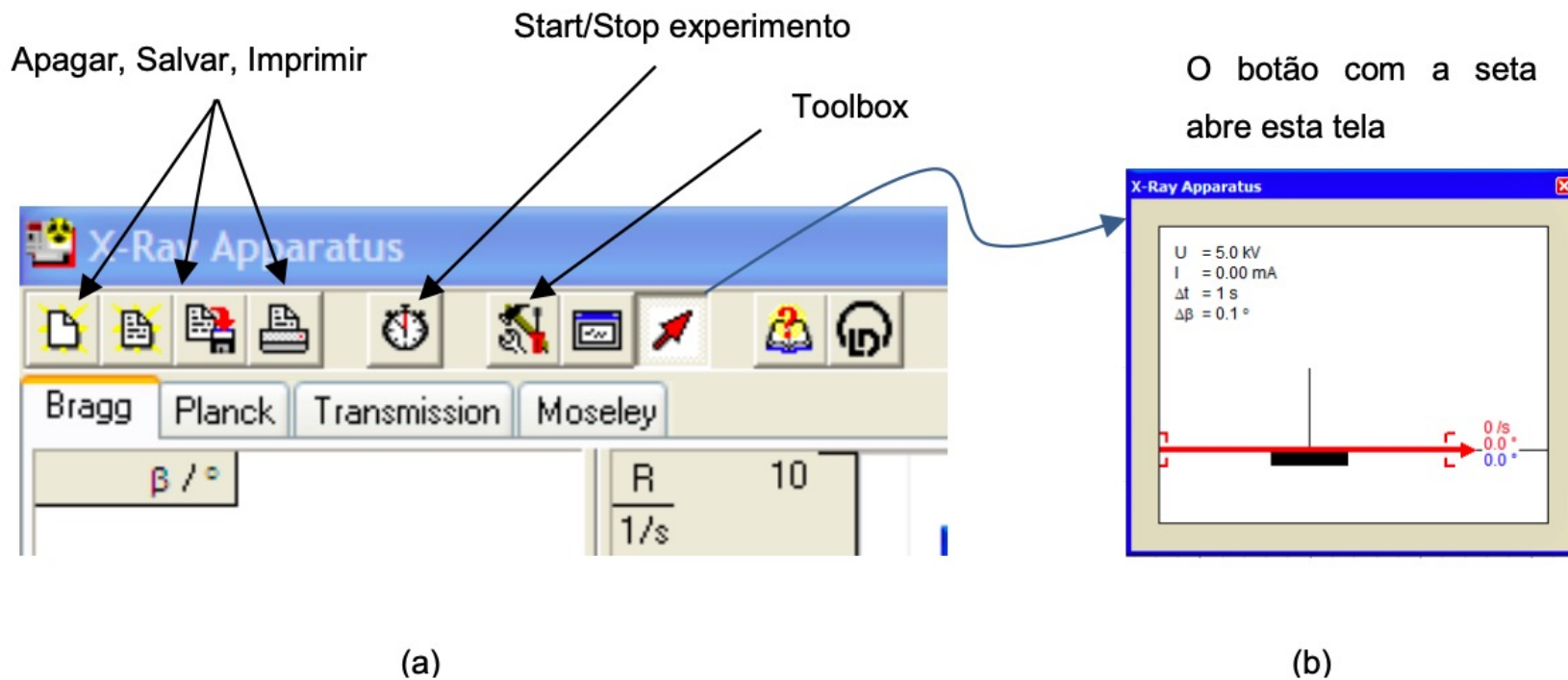
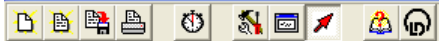
R  
1/s

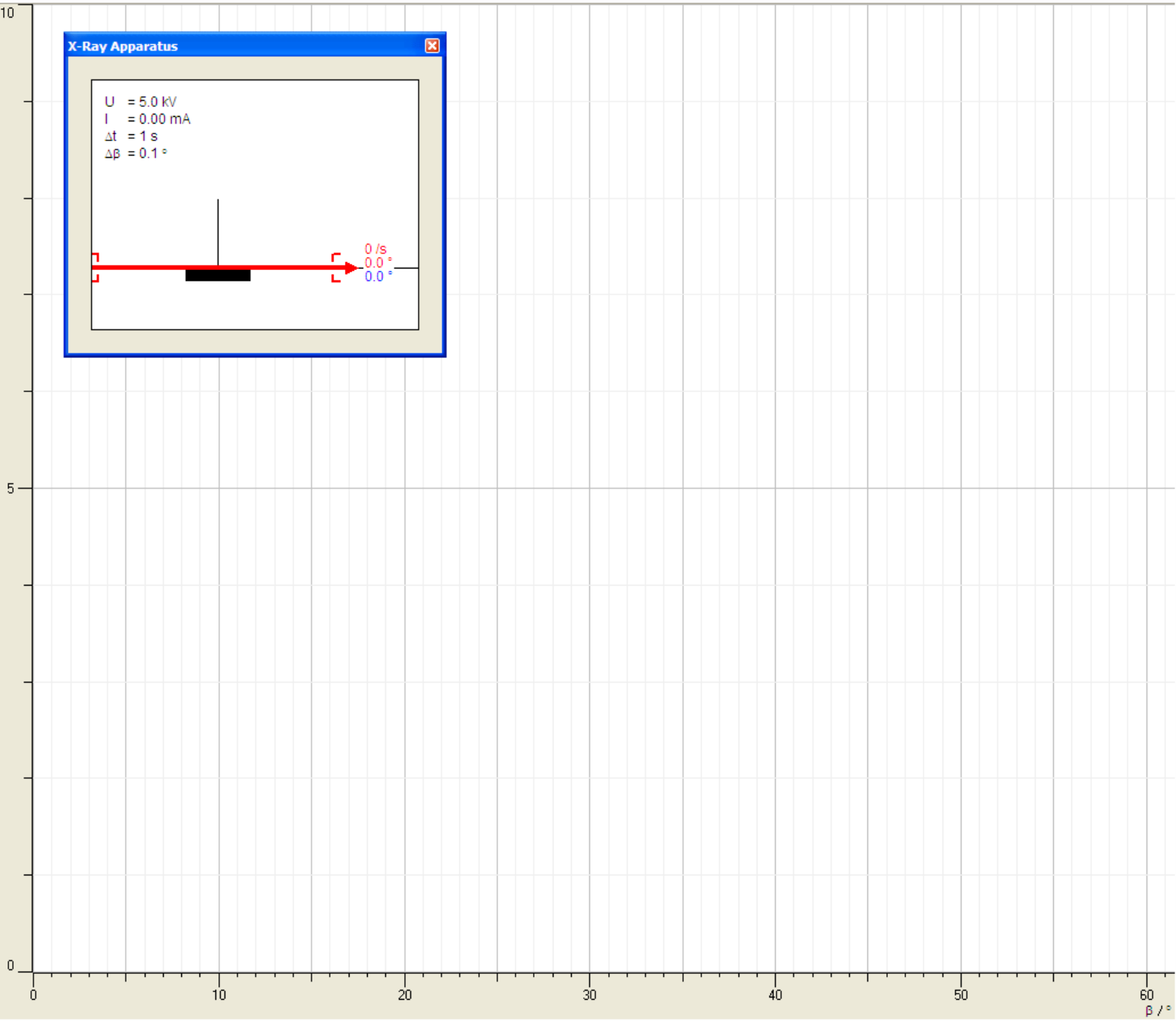
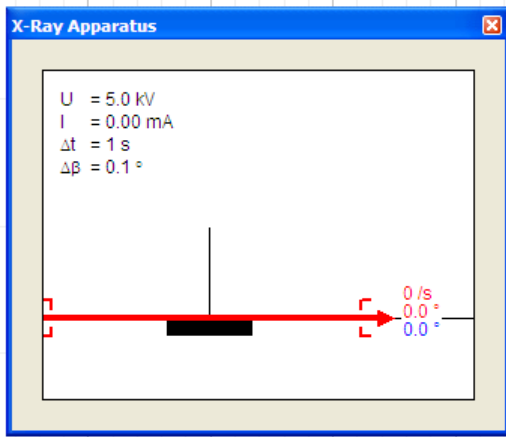

# X-Ray Apparatus



Bragg Planck Transmission Moseley

$\beta / ^\circ$

R 10  
1/s

## X-Ray Apparatus

U = 5.0 kV  
I = 0.00 mA  
 $\Delta t = 1$  s  
 $\Delta\beta = 0.1$  °

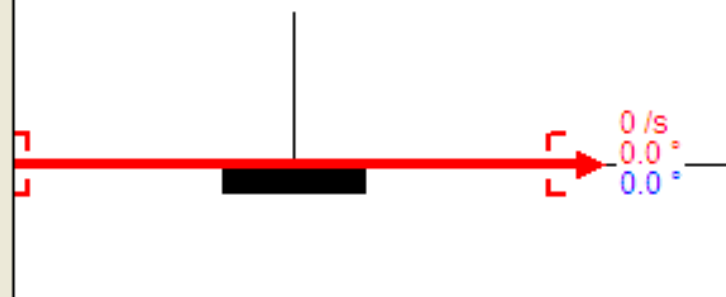



# Aquisição dos dados

Parte 1 – Difração de Bragg

Salvar / apagar area de trabalho

Parar / reiniciar medições

Ajustes dos parâmetros experimentais

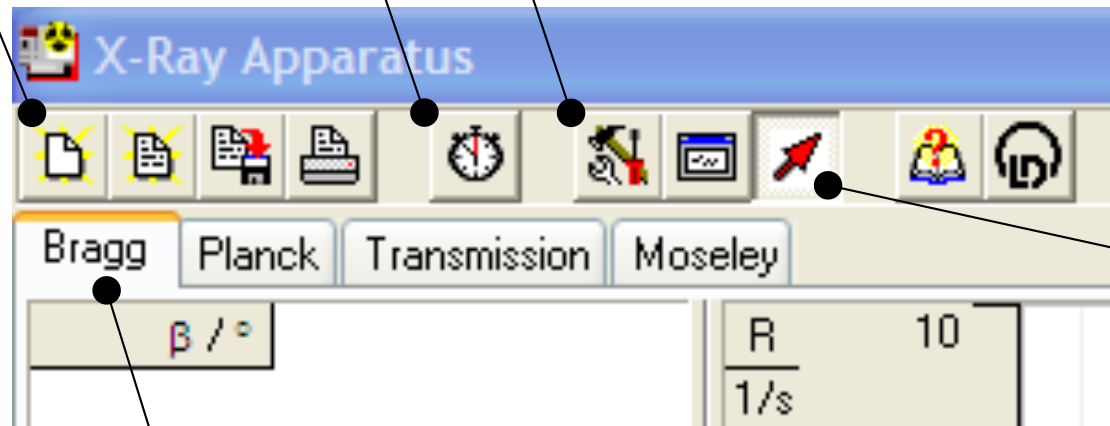

Visualização dos ângulos

1ª parte – difratometria de Bragg p/medir "*d*"

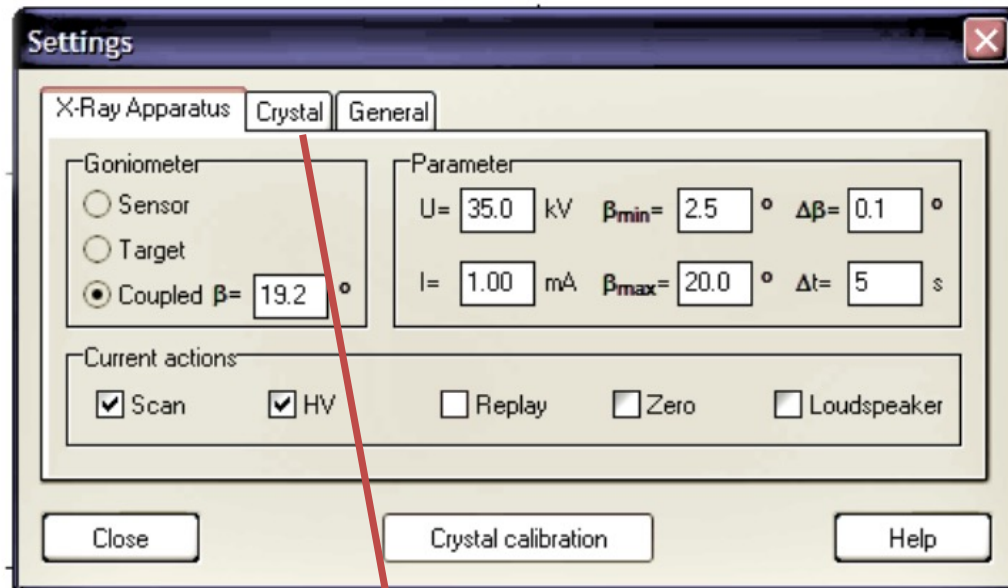
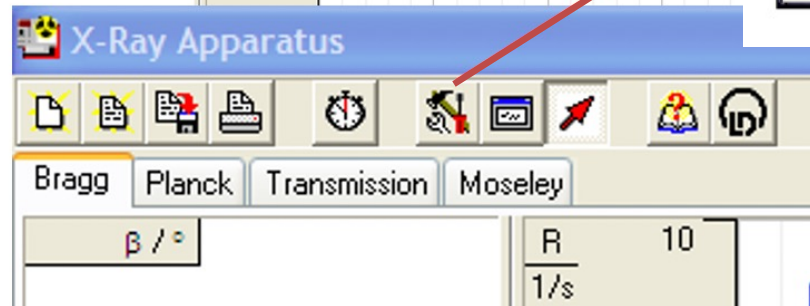

Ajuste do eixo X para experimento de Bragg

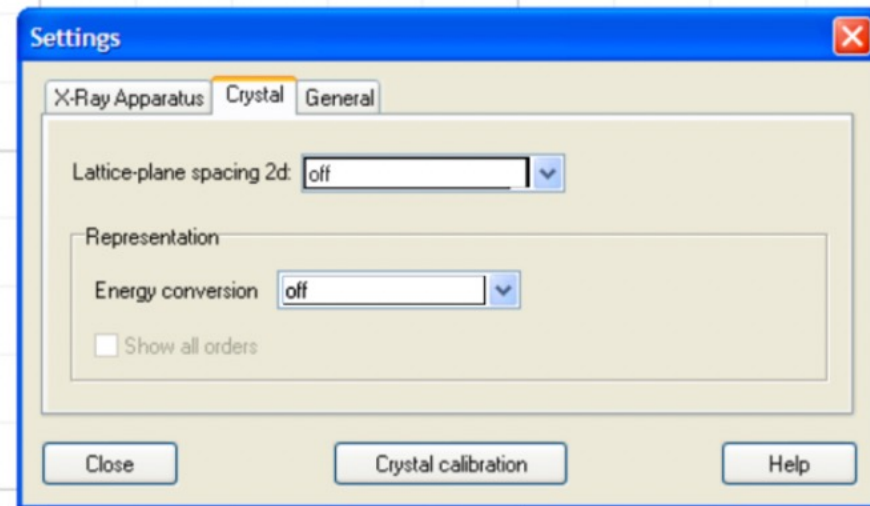

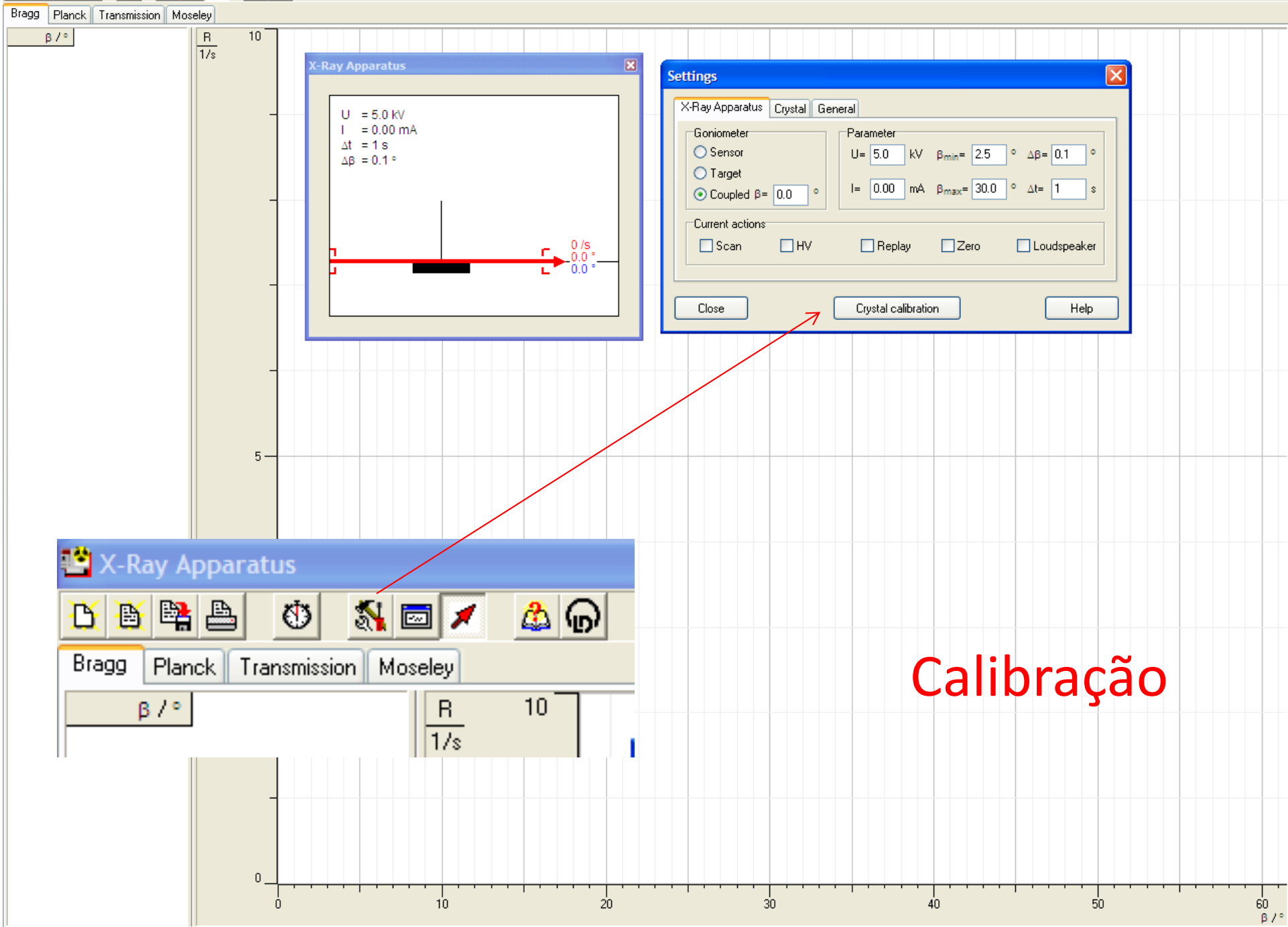

Calibração



Bragg Planck Transmission Moseley

$\beta / ^\circ$

R

1/s

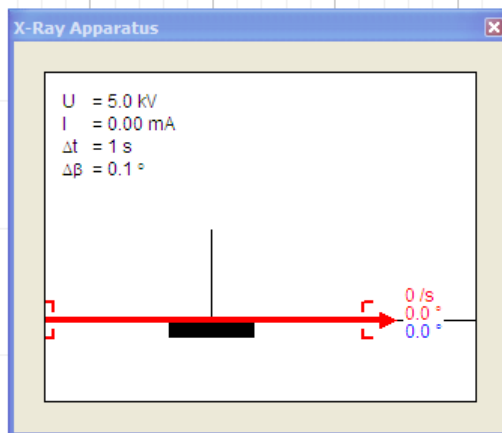

### Settings

X-Ray Apparatus Crystal General

Goniometer  
 Sensor  
 Target  
 Coupled  $\beta = 0.0^\circ$

Parameter  
 U= 5.0 kV  $\beta_{min} = 2.5^\circ$   $\Delta\beta = 0.1^\circ$   
 I= 0.00 mA  $\beta_{max} = 30.0^\circ$   $\Delta t = 1$  s

Current actions  
 Scan  HV  Replay  Zero  Loudspeaker

Close Crystal calibration Help

### Crystal calibration

Crystal and anode  
 0° (without target table)  
 Crystal: NaCl (2d = 564.0 pm)  
 Anode: Mo ( $K_{\alpha} = 17.44$  keV)  
 Target angle: 7.2°

Progress  
 Target angle: 0.0°  
 Sensor angle: 0.0°  
 Counting rate: 0 /s

The calibration of a crystal should be carried out after every crystal change or after every re-orientation of a crystal. This will be saved in the x-ray apparatus until the next calibration.

The 0° calibration (without target table) is sensible for Debye-Scherrer scans (powder targets).  
 For Bragg scans (single crystal), it is only necessary if the sensor angle has become so maladjusted that the automatic crystal calibration can no longer find the counting rate maximum.

Start search Cancel Adopt

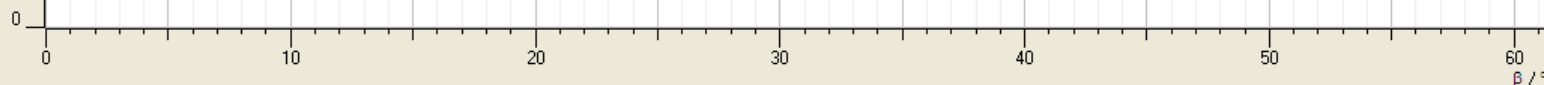
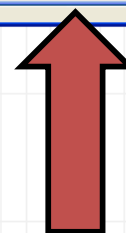

Bragg Planck Transmission Moseley

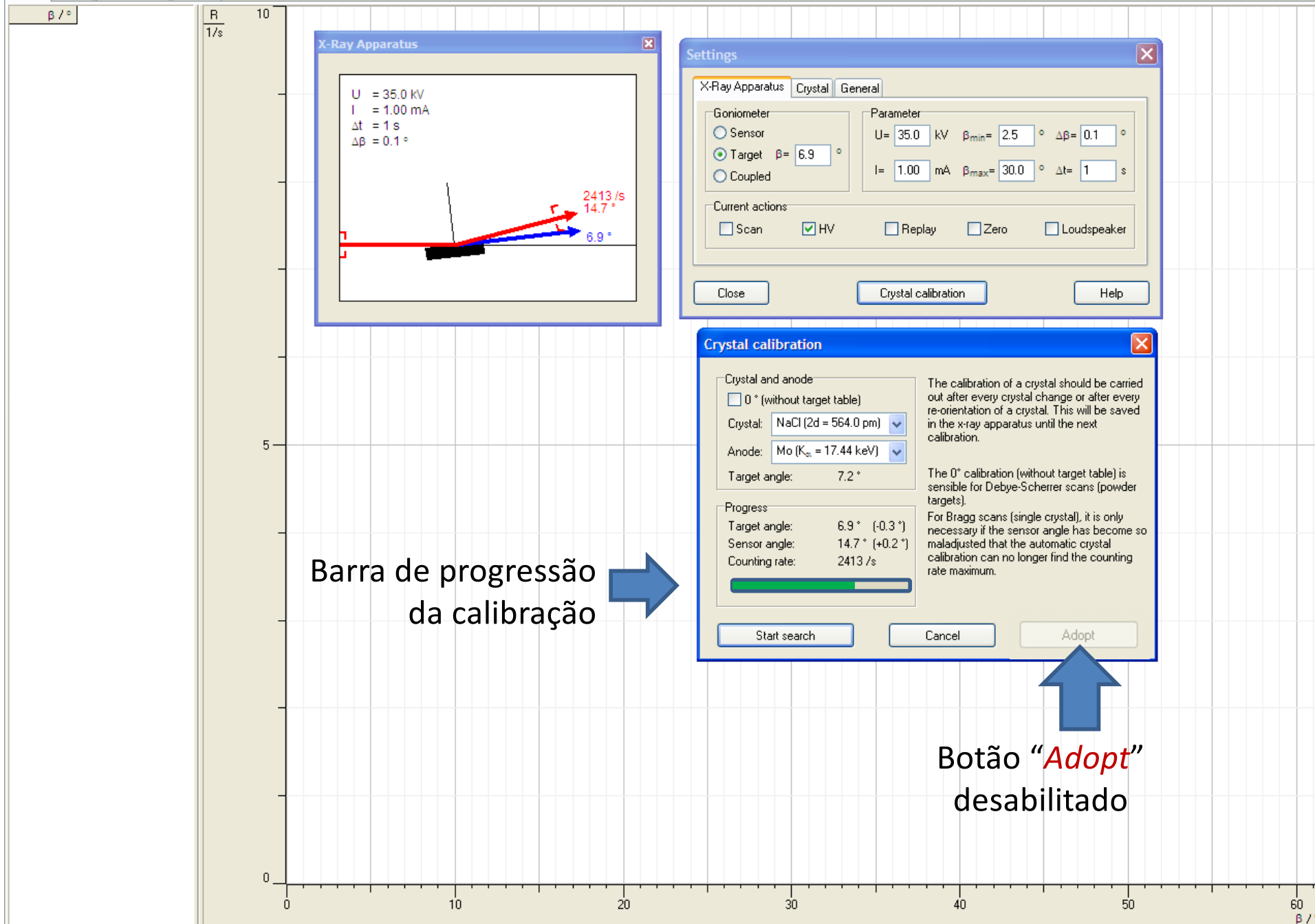

Bragg Planck Transmission Moseley

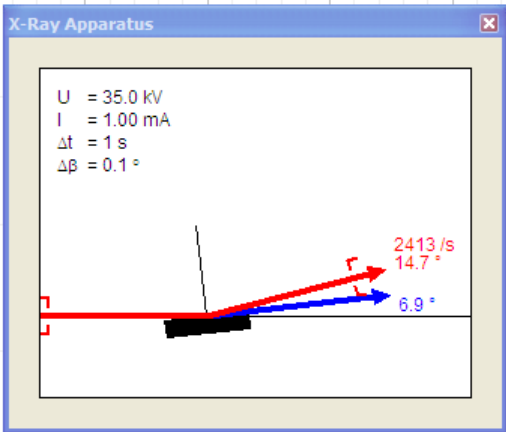
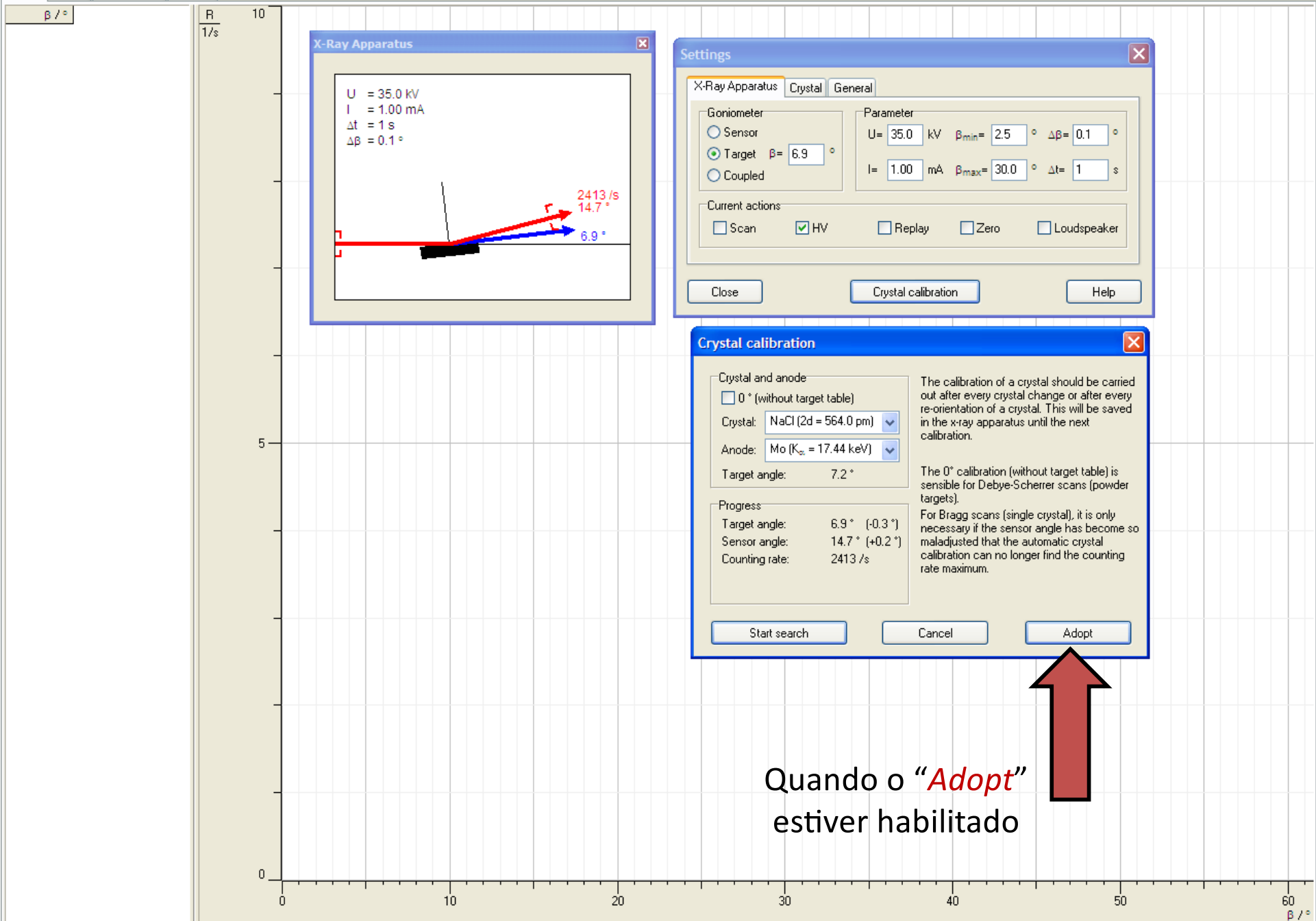

**Settings**

X-Ray Apparatus Crystal General

Goniometer

Sensor

Target  $\beta = 6.9^\circ$

Coupled

Parameter

U = 35.0 kV  $\beta_{min} = 2.5^\circ$   $\Delta\beta = 0.1^\circ$

I = 1.00 mA  $\beta_{max} = 30.0^\circ$   $\Delta t = 1$  s

Current actions

Scan  HV  Replay  Zero  Loudspeaker

Close Crystal calibration Help

**Crystal calibration**

Crystal and anode

0° (without target table)

Crystal: NaCl (2d = 564.0 pm)

Anode: Mo ( $K_{\alpha} = 17.44$  keV)

Target angle: 7.2°

Progress

Target angle: 6.9° (-0.3°)

Sensor angle: 14.7° (+0.2°)

Counting rate: 2413 /s

The calibration of a crystal should be carried out after every crystal change or after every re-orientation of a crystal. This will be saved in the x-ray apparatus until the next calibration.

The 0° calibration (without target table) is sensible for Debye-Scherrer scans (powder targets).

For Bragg scans (single crystal), it is only necessary if the sensor angle has become so maladjusted that the automatic crystal calibration can no longer find the counting rate maximum.

Start search Cancel Adopt

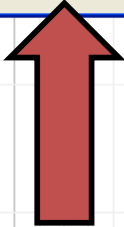

Quando o "Adopt" estiver habilitado

Bragg Planck Transmission Moseley

$\beta / ^\circ$	$R_0 / 1/s$	R
15.3	56.4	1/s
15.4	56.0	
15.5	56.6	
15.6	52.4	
15.7	52.8	
15.8	51.2	
15.9	51.0	
16.0	45.2	
16.1	48.6	
16.2	40.2	
16.3	45.0	
16.4	49.0	
16.5	44.2	
16.6	39.2	
16.7	44.4	
16.8	40.4	
16.9	38.4	
17.0	38.8	
17.1	37.6	
17.2	43.4	
17.3	33.0	
17.4	34.0	
17.5	32.8	
17.6	29.6	
17.7	33.0	
17.8	32.6	
17.9	31.6	
18.0	37.4	
18.1	35.0	
18.2	25.4	
18.3	32.0	
18.4	33.2	
18.5	26.8	
18.6	27.0	
18.7	28.6	
18.8	27.4	
18.9	27.4	
19.0	29.0	
19.1	26.6	
19.2	30.0	
19.3	30.0	
19.4	38.2	
19.5	47.0	
19.6	47.2	
19.7	40.4	
19.8	28.2	
19.9	24.6	
20.0	24.8	

Ajuste dos parâmetros e disposição ideal das janelas

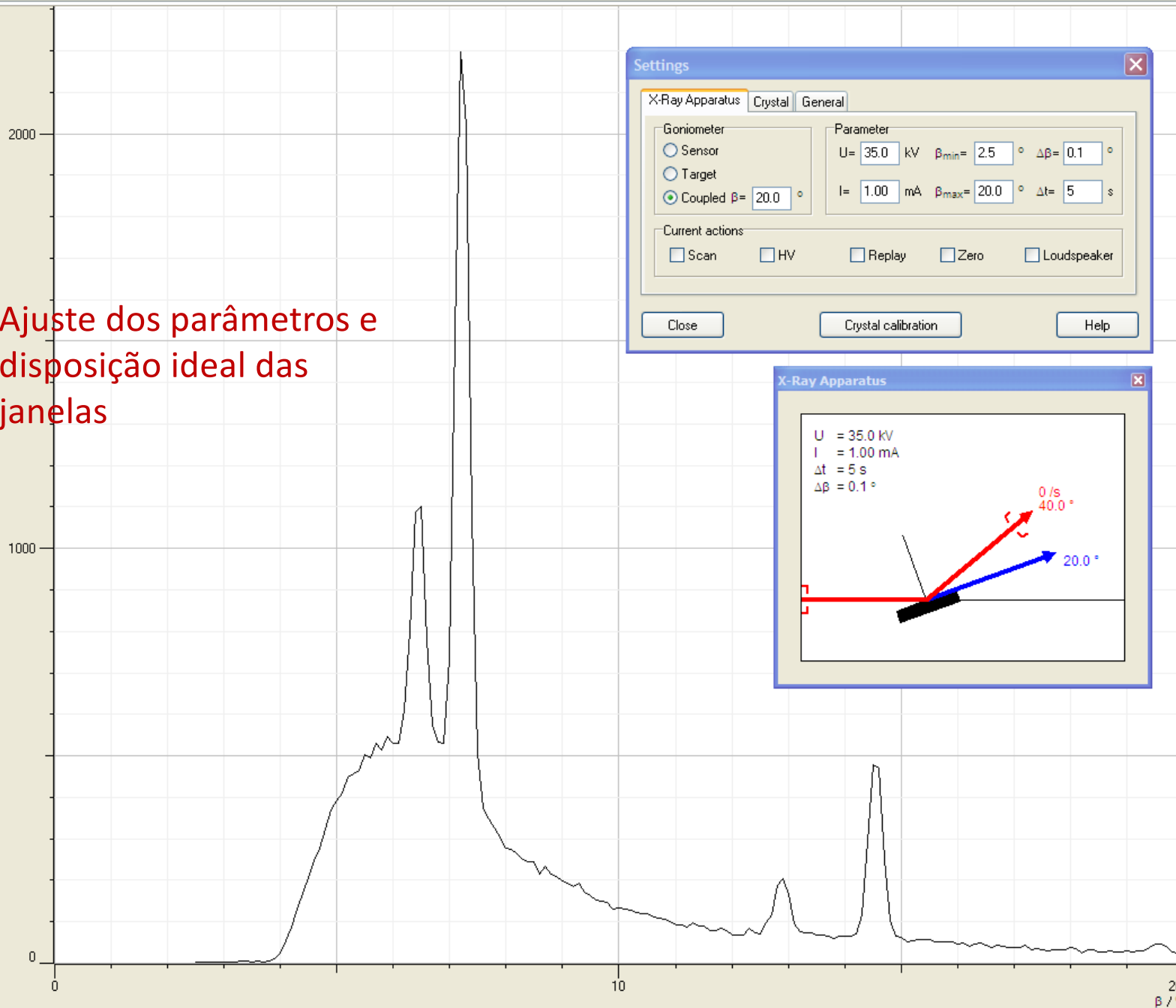

**Settings**

X-Ray Apparatus Crystal General

Goniometer  
 Sensor  
 Target  
 Coupled  $\beta = 20.0^\circ$

Parameter  
 U = 35.0 kV  $\beta_{min} = 2.5^\circ$   $\Delta\beta = 0.1^\circ$   
 I = 1.00 mA  $\beta_{max} = 20.0^\circ$   $\Delta t = 5$  s

Current actions  
 Scan  HV  Replay  Zero  Loudspeaker

Close Crystal calibration Help

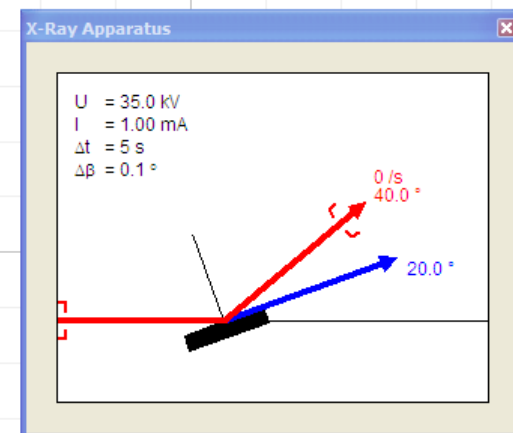

Atenção: a ação "scan" só deve ser ativada após ter entrado todos parâmetros

35 kV

2.5°

30.0°

Passo Angular  $\Delta\beta = 0.1^\circ$

Tempo de Contagem

ignorar

iniciar

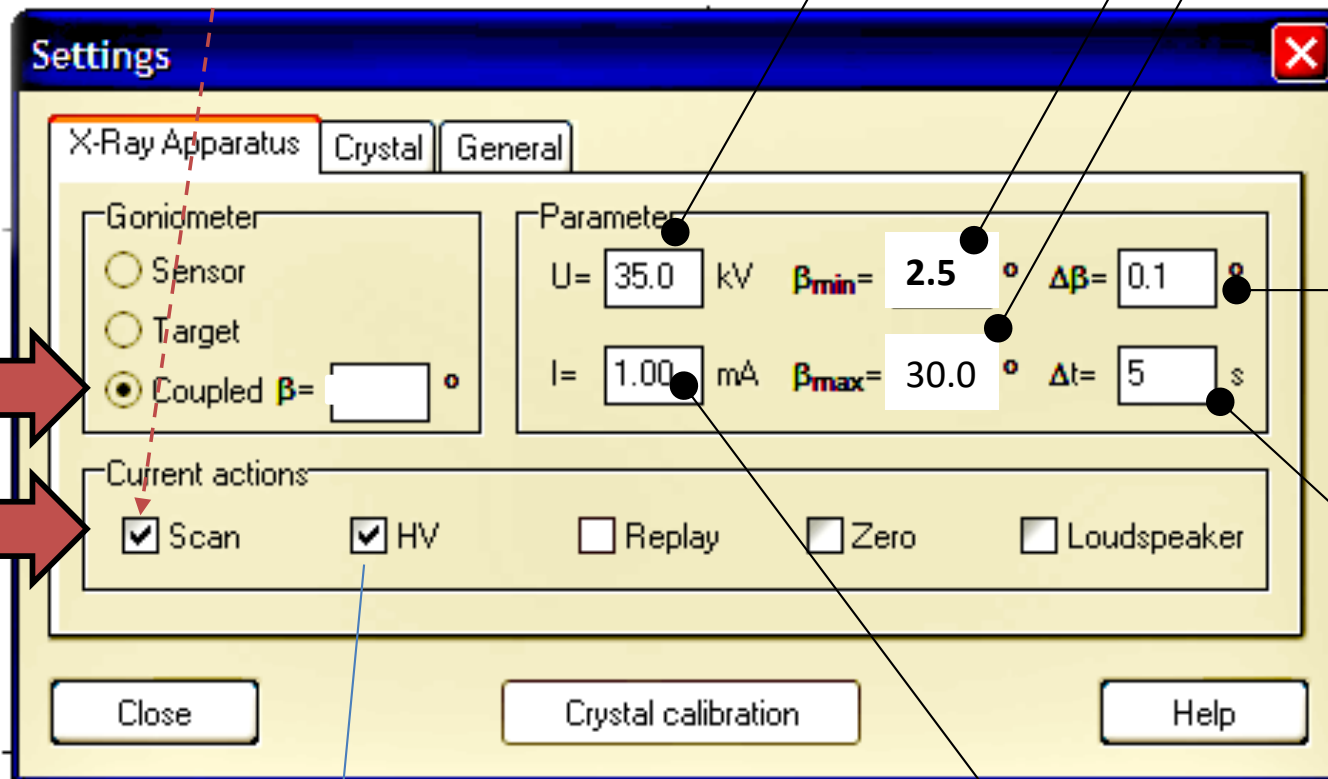

Após iniciar, o equipamento ativa essa indicação

1 mA

Bragg Planck Transmission Moseley

$\beta / ^\circ$	$R_0 / 1/s$	R
2.5	2.8	1/s
2.6	2.8	
2.7	2.8	
2.8	3.0	
2.9	3.2	
3.0	1.8	
3.1	2.8	
3.2	3.6	
3.3	5.6	
3.4	4.4	
3.5	4.0	
3.6	6.0	
3.7	4.0	
3.8	6.6	
3.9	10.2	
4.0	24.4	
4.1	55.2	
4.2	85.8	
4.3	131.4	
4.4	168.4	
4.5	205.4	
4.6	247.8	
4.7	278.0	
4.8	324.8	
4.9	369.4	
5.0	391.6	
5.1	410.6	
5.2	449.0	
5.3	457.2	
5.4	465.4	
5.5	502.8	
5.6	495.2	
5.7	529.6	
5.8	514.8	
5.9	546.0	
6.0	531.6	
6.1	529.4	
6.2	608.2	
6.3	798.6	
6.4	1086.4	
6.5	1100.0	
6.6	779.4	
6.7	574.4	
6.8	533.8	
6.9	529.4	
7.0	734.4	
7.1	1514.0	
7.2	2196.2	

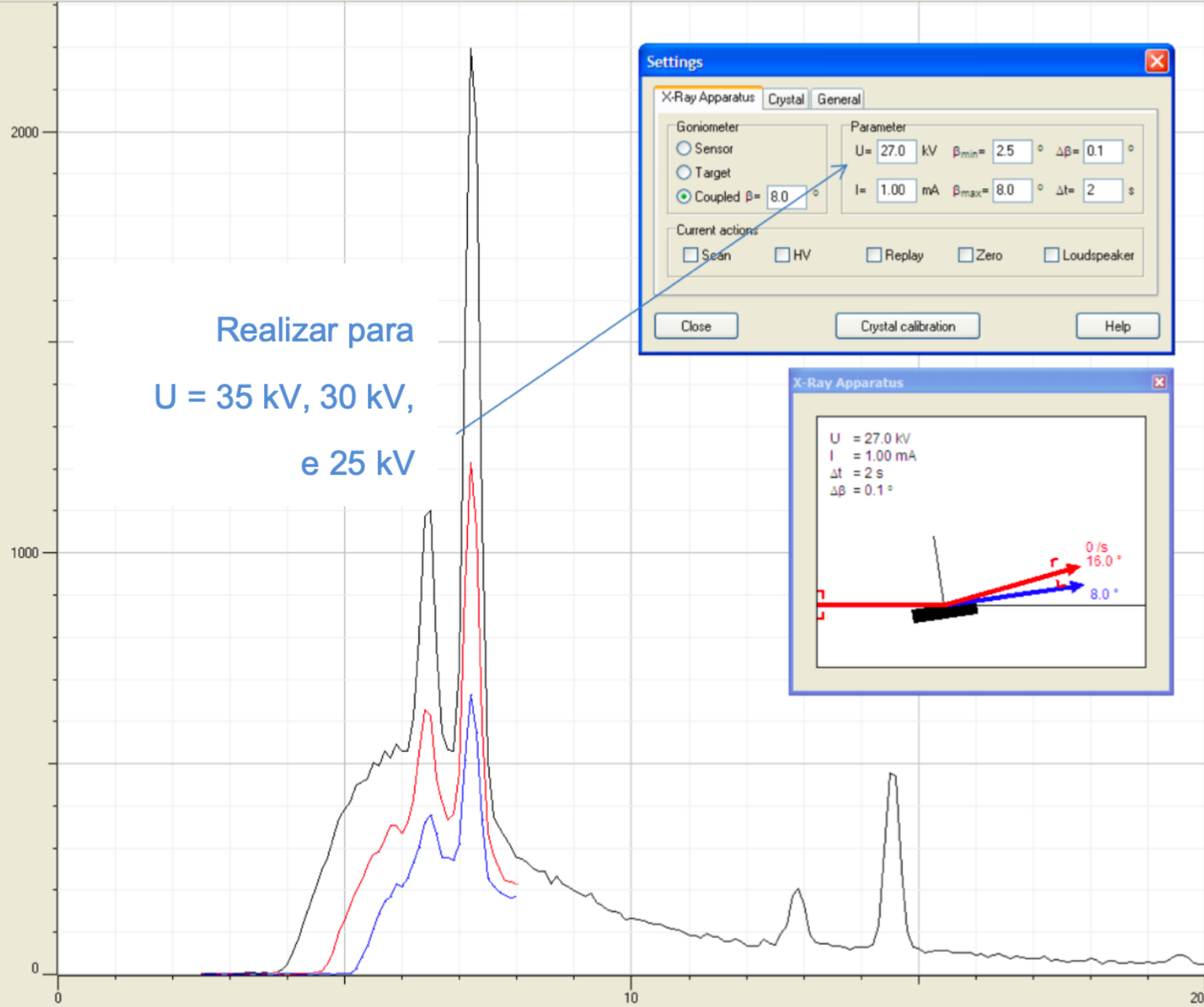

Realizar para  
 $U = 35 \text{ kV}, 30 \text{ kV},$   
 e  $25 \text{ kV}$

**Settings**

X-Ray Apparatus Crystal General

Goniometer  
 Sensor  
 Target  
 Coupled  $\beta = 8.0^\circ$

Parameter  
 $U = 27.0 \text{ kV}$   $\beta_{\min} = 2.5^\circ$   $\Delta\beta = 0.1^\circ$   
 $I = 1.00 \text{ mA}$   $\beta_{\max} = 8.0^\circ$   $\Delta t = 2 \text{ s}$

Current actions  
 Scan  HV  Replay  Zero  Loudspeaker

Close Crystal calibration Help

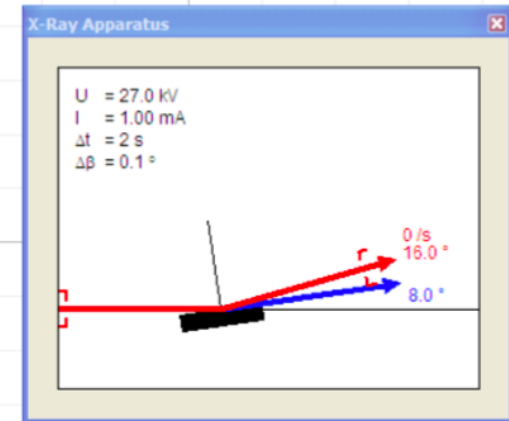

A figura apresenta os gráficos que resultarão das 3 etapas de medida, cada uma correspondendo a um valor de tensão aceleradora  $U$ . Para que os três gráficos apareçam conjuntamente na mesma tela, como mostrado na fig.7, você deve executar cada etapa de medição sem apagar os dados anteriores. **É fortemente aconselhável salvar os dados entre uma etapa e a seguinte.**

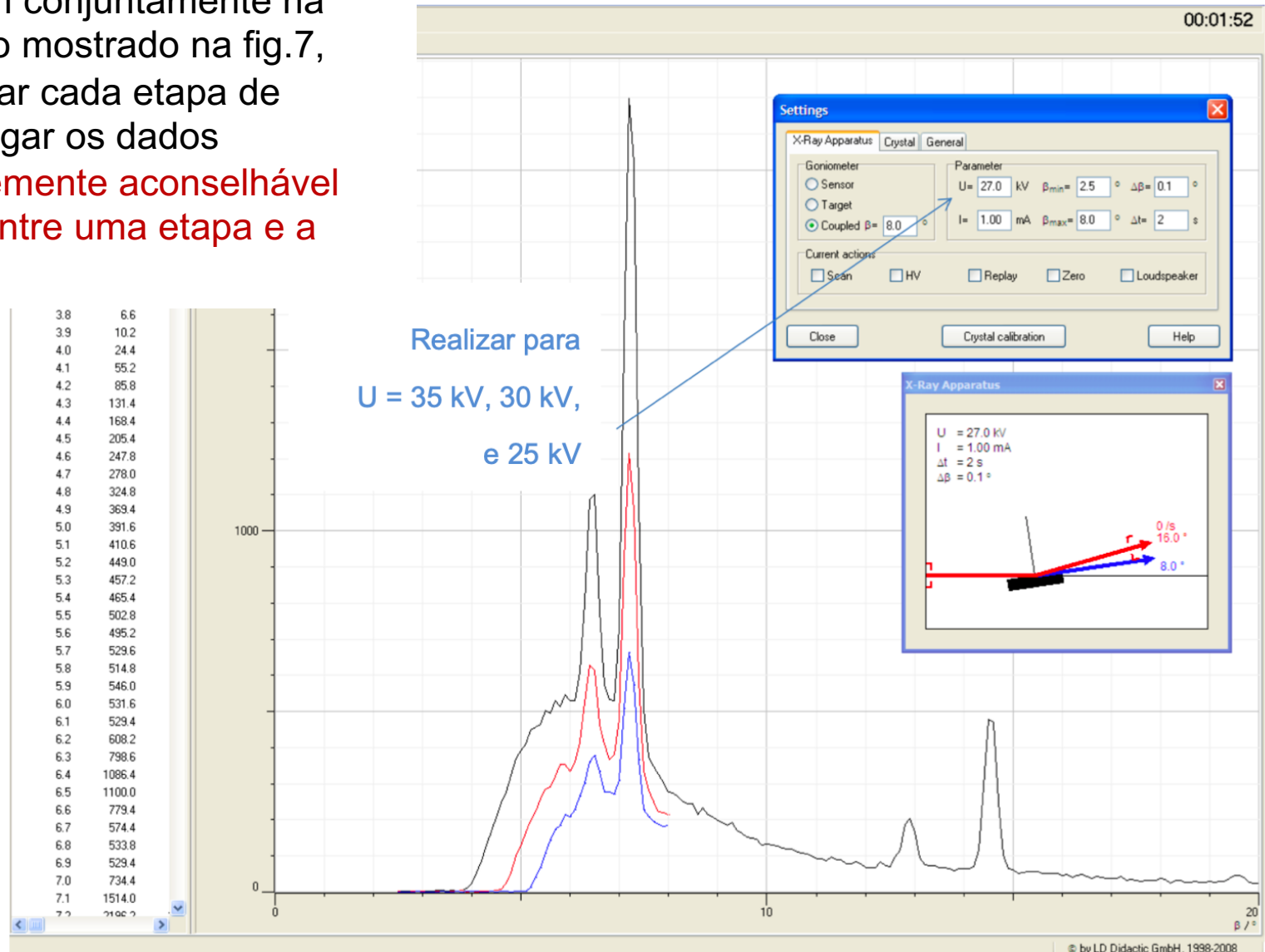



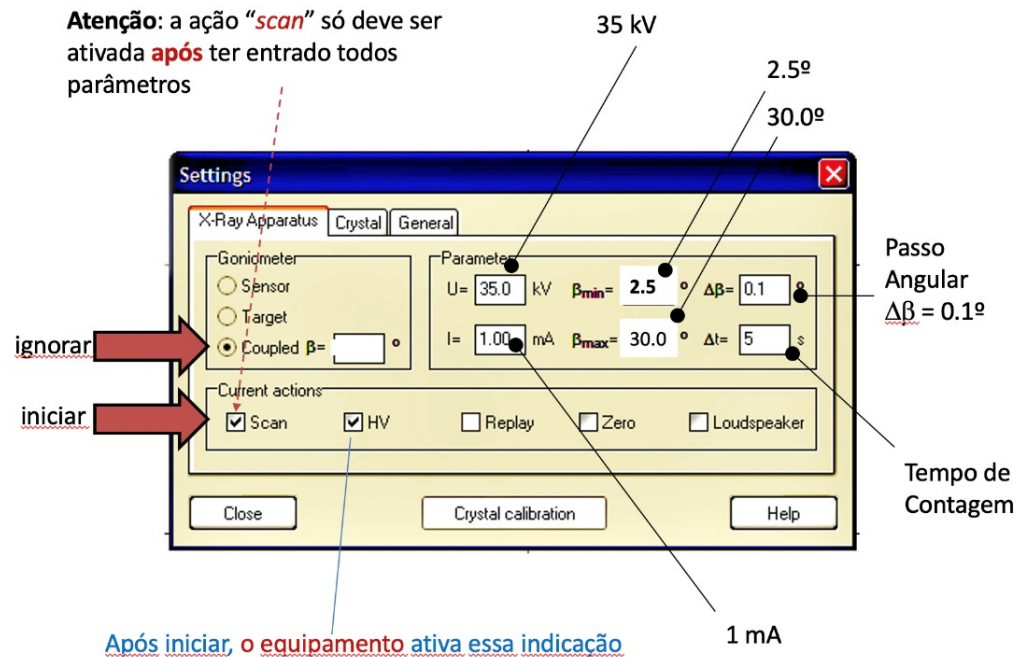

A duração aproximada da tomada de dados do primeiro experimento é de **90 minutos** ( 3 sessões de 30 minutos, uma para cada valor de U ).

Cada linha da tabela I constitui uma etapa. Note que apenas os valores da 1ª coluna mais à esquerda é que mudam a cada etapa – são os valores da tensão a ser aplicada ao tubo de raio-X. Os valores das demais colunas se repetem nas 3 etapas.

TABELA I

Tensão U (kV)	Corrente I (mA)	$\beta_{min}$ (graus)	$\beta_{max}$ (graus)	$\Delta\beta$ (graus)	$\Delta t$ (seg)
35	1	2,5	30	0,1	5
30	1	2,5	30	0,1	5
25	1	2,5	30	0,1	5

São 3 etapas:  
35 kV  
30 kV  
25 kV

É fortemente aconselhável salvar os dados entre uma etapa e a seguinte.

# Aquisição dos dados

**Parte 2** – Determinação da constante de Planck pelo experimento de Duane-Hunt

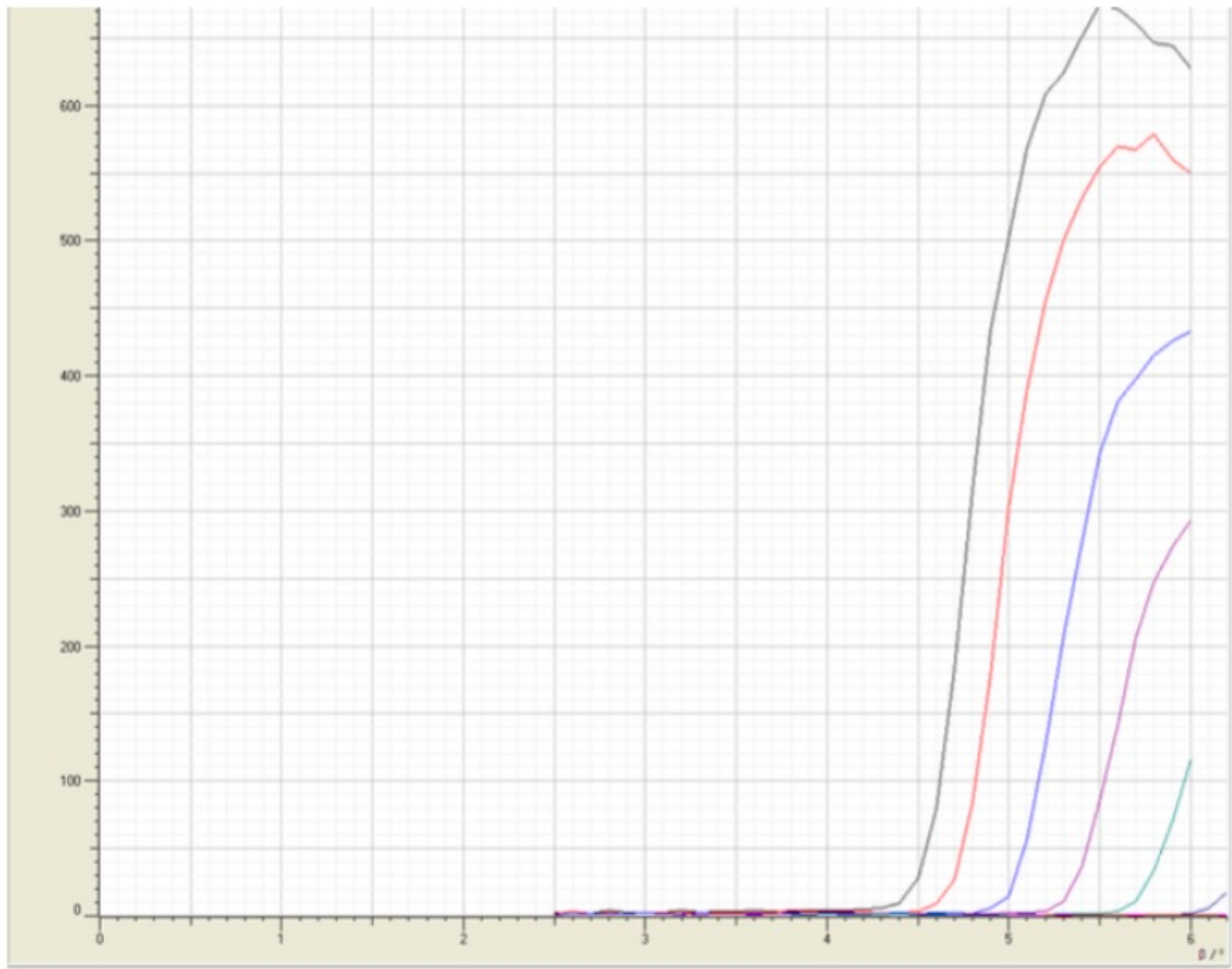

Curvas de espectro de Bremsstrahlung

Cuidado ! Eixo das abcissas em  $\mu\text{m}$  ( $n\lambda$ )

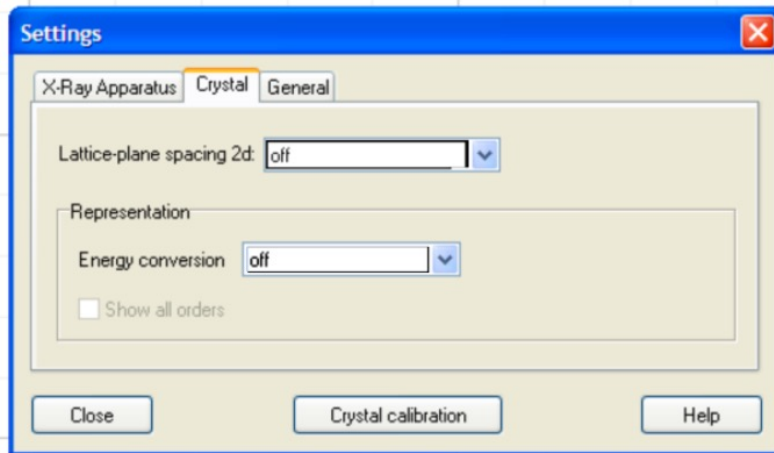

(a)

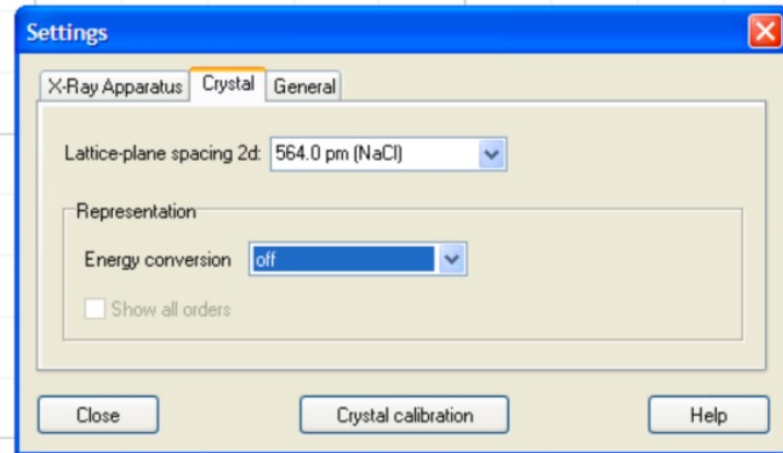

(b)

Configurações do painel *Settings* para cada experimento. (a) Configuração usada no primeiro experimento (difração de Bragg). As duas caixas devem ficar em off. (b) Configuração usada no segundo experimento (determinação de  $h$ ). Informar o valor de  $d$  na caixa de cima e a outra deixar em off.

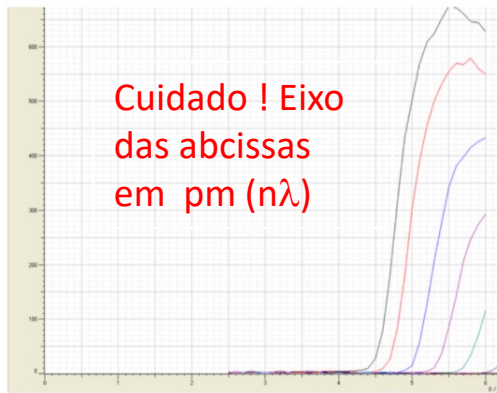

Curvas de espectro de Bremsstrahlung

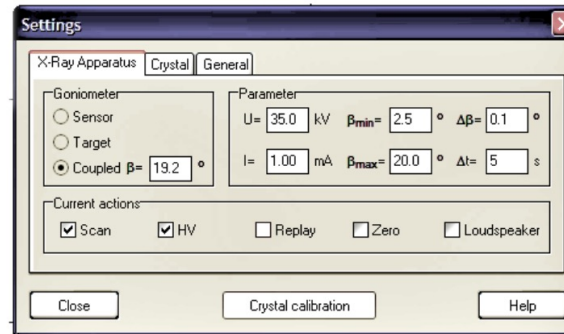

Não esqueça de limpar a área de gráficos na janela do programa antes de começar a fazer as aquisições.

TABELA II

$\frac{U}{\text{kV}}$	$\frac{I}{\text{mA}}$	$\frac{\Delta t}{\text{s}}$	$\frac{\beta_{min}}{\text{grd}}$	$\frac{\beta_{max}}{\text{grd}}$	$\frac{\Delta\beta}{\text{grd}}$
22	1.00	30	5.2	6.2	0.1
24	1.00	30	5.0	6.2	0.1
26	1.00	20	4.5	6.2	0.1
28	1.00	20	3.8	6.0	0.1
30	1.00	10	3.2	6.0	0.1
32	1.00	10	2.5	6.0	0.1
34	1.00	10	2.5	6.0	0.1
35	1.00	10	2.5	6.0	0.1

Quando terminar de realizar as medidas correspondentes a cada linha da tabela II, **salve os dados** (**CAUIDADO!** : salve em um arquivo diferente daquele que salvou os dados do experimento de Bragg).

**Sugestão:** realize o experimento seguindo a tabela **de baixo para cima**

# Análise dos dados

Feita com auxílio do programa  
X ray apparatus

## Parte 1 - Análise da difração de Bragg

1. Determinar os centros dos picos
2. Determinar as incertezas dos centros
3. Calcular os valores da distância interatômica  $d$

Voltar à configuração para Bragg

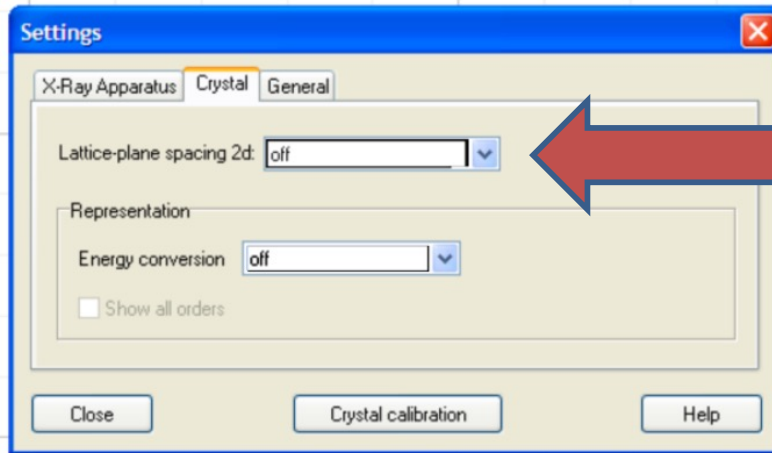

(a)

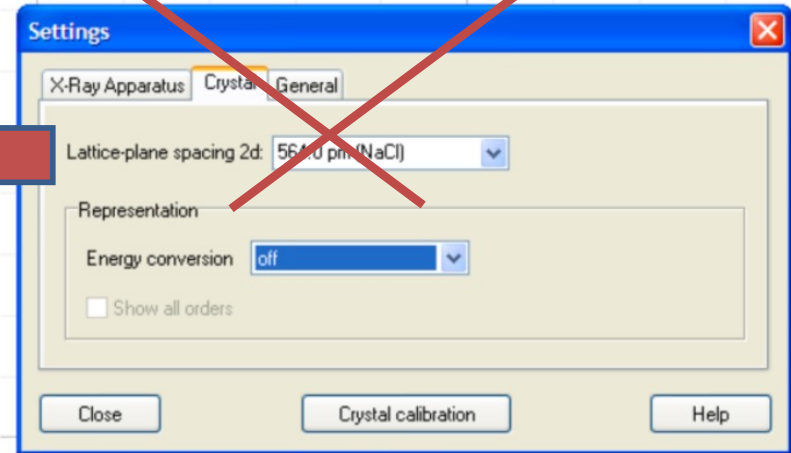

(b)

Configurações do painel *Settings* para cada experimento. (a) Configuração usada no primeiro experimento (difração de Bragg). As duas caixas devem ficar em off. (b) Configuração usada no segundo experimento (determinação de  $h$ ). Informar o valor de  $d$  na caixa de cima e a outra deixar em off.



Bragg Planck Transmission Moseley

$n_i$ / pm	$R_0$ / 1/s
24.6	2.8
25.6	2.8
26.6	2.8
27.6	3.0
28.5	3.2
29.5	1.8
30.5	2.8
31.5	3.6
32.5	5.6
33.4	4.4
34.4	4.0
35.4	6.0
36.4	4.0
37.4	6.6
38.4	10.2
39.3	24.4
40.3	55.2
41.3	85.8
42.3	131.4
43.3	168.4
44.3	205.4
45.2	247.8
46.2	278.0
47.2	324.8
48.2	369.4
49.2	391.6
50.1	410.6
51.1	449.0
52.1	457.2
53.1	465.4
54.1	502.8
55.0	495.2
56.0	529.6
57.0	514.8
58.0	546.0
59.0	531.6
59.9	529.4
60.9	608.2
61.9	798.6
62.9	1086.4
63.8	1100.0
64.8	779.4
65.8	574.4
66.8	533.8
67.8	529.4
68.7	734.4
69.7	1514.0
70.7	2196.2
71.7	2916.0

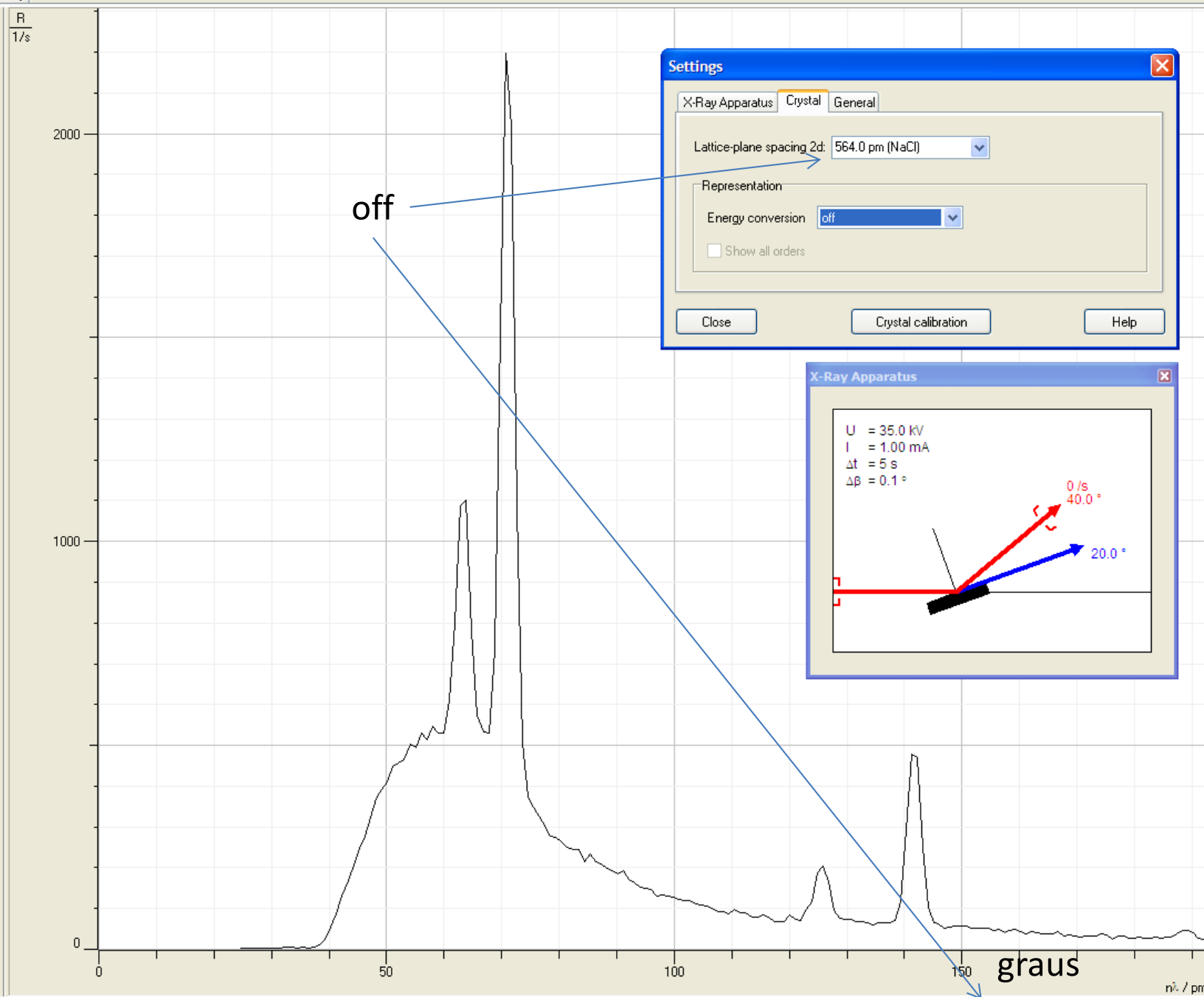

off

**Settings**

X-Ray Apparatus Crystal General

Lattice-plane spacing 2d: 564.0 pm (NaCl)

Representation

Energy conversion: off

Show all orders

Close Crystal calibration Help

**X-Ray Apparatus**

U = 35.0 kV  
 I = 1.00 mA  
 Δt = 5 s  
 Δβ = 0.1 °

Bragg Planck Transmission Moseley

$\beta / ^\circ$	$R_0 / 1/s$	R
15.3	56.4	1/s
15.4	56.0	

- Properties
- Delete Column
- Select Character Size

---

- Display Coordinates Alt+C
- Select Line Width
- Show Values
- ✓ Show Connecting Lines
- Select Rulers
- ✓ Show Grid
- Logarithmic Representation
- Zoom Alt+Z
- Zoom Off Alt+O

---

- Set Marker
- Calculate Peak Center
- Draw K-edge
- Calculate Best-fit Straight Line
- Calculate Straight Line through Origin
- Calculate Integral

---

- Delete Last Evaluation Alt+Rück
- Delete All Evaluations

---

- Copy Table
- Copy Diagram
- Copy Window

Settings

X-Ray Apparatus Crystal General

Goniometer

Sensor

Target

Coupled  $\beta = 20.0^\circ$

Parameter

U = 35.0 kV  $\beta_{min} = 2.5^\circ$   $\Delta\beta = 0.1^\circ$

I = 1.00 mA  $\beta_{max} = 20.0^\circ$   $\Delta t = 5$  s

Current actions

Scan  HV  Replay  Zero  Loudspeaker

Close Crystal calibration Help

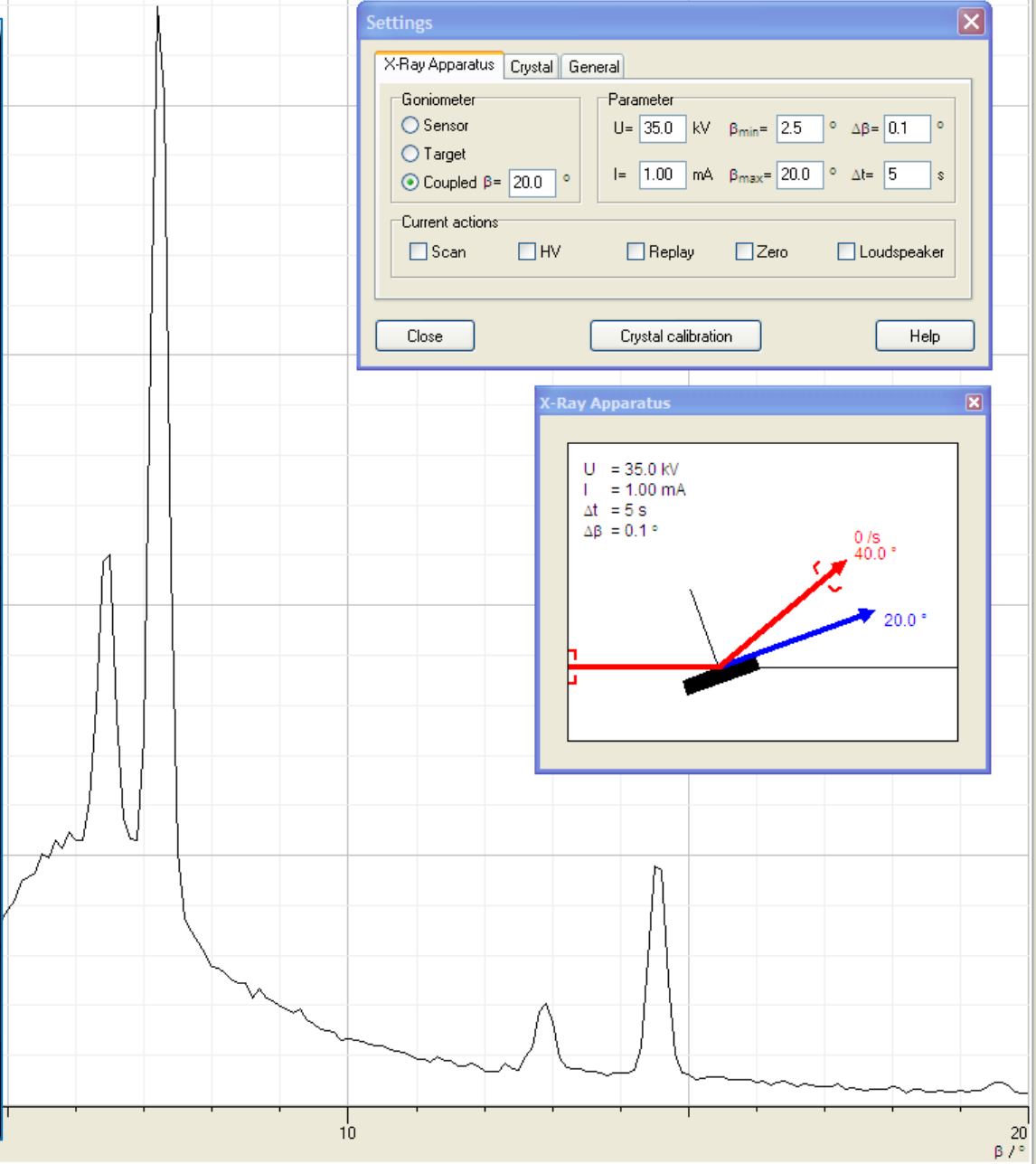
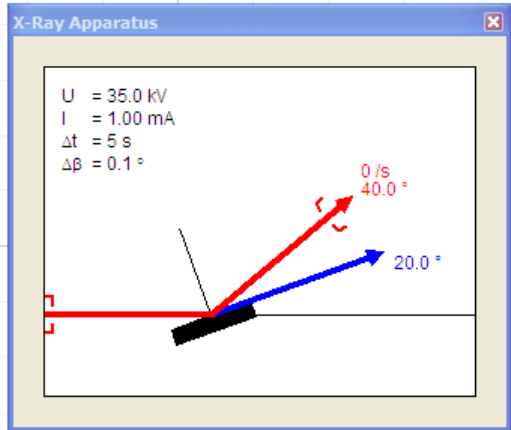

Bragg Planck Transmission Moseley

$n\lambda$ / pm	$R_0$ / 1/s
26.6	2.8
27.6	3.0
28.5	3.2
29.5	1.8
30.5	2.8
31.5	3.6
32.5	5.6
33.4	4.4
34.4	4.0
35.4	6.0
36.4	4.0
37.4	6.6
38.4	10.2
39.3	24.4
40.3	55.2
41.3	85.8
42.3	131.4
43.3	168.4
44.3	205.4
45.2	247.8
46.2	278.0
47.2	324.8
48.2	369.4
49.2	391.6
50.1	410.6
51.1	449.0
52.1	457.2
53.1	465.4
54.1	502.8
55.0	495.2
56.0	529.6
57.0	514.8
58.0	546.0
59.0	531.6
59.9	529.4
60.9	608.2
61.9	798.6
62.9	1086.4
63.8	1100.0
64.8	779.4
65.8	574.4
66.8	533.8
67.8	529.4
68.7	734.4
69.7	1514.0
70.7	2196.2
71.7	2016.8
72.6	1081.2
73.6	584.6

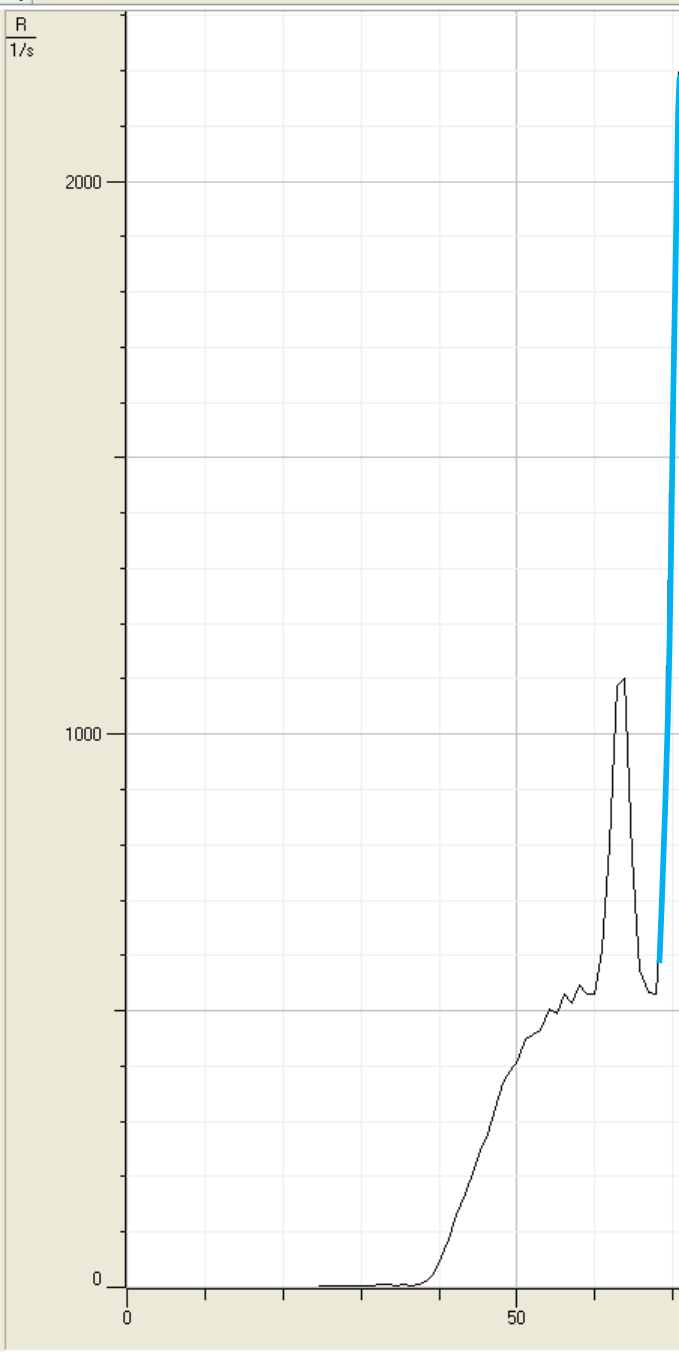

**Settings**

X-Ray Apparatus Crystal General

Lattice-plane spacing 2d: 564.0 pm (NaCl)

Representation

Energy conversion: off

Show all orders

Close Crystal calibration Help

**X-Ray Apparatus**

U = 35.0 kV  
 I = 1.00 mA  
 Δt = 5 s  
 Δβ = 0.1 °

- Properties
- Delete Column
- Select Character Size
- Display Coordinates Alt+C
- Select Line Width
- Show Values
- Show Connecting Lines
- Select Rulers
- Show Grid
- Logarithmic Representation
- Zoom Alt+Z
- Zoom Off Alt+O
- Set Marker
- Calculate Peak Center
- Draw K-edge
- Calculate Best-fit Straight Line
- Calculate Straight Line through Origin
- Calculate Integral
- Delete Last Evaluation Alt+Rück
- Delete All Evaluations
- Copy Table
- Copy Diagram
- Copy Window

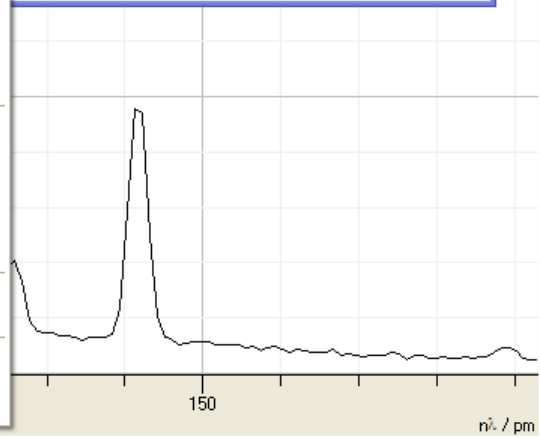

Bragg Planck Transmission Moseley

$n_i$ / pm	$R_0$ / 1/s
26.6	2.8
27.6	3.0
28.5	3.2
29.5	1.8
30.5	2.8
31.5	3.6
32.5	5.6
33.4	4.4
34.4	4.0
35.4	6.0
36.4	4.0
37.4	6.6
38.4	10.2
39.3	24.4
40.3	55.2
41.3	85.8
42.3	131.4
43.3	168.4
44.3	205.4
45.2	247.8
46.2	278.0
47.2	324.8
48.2	369.4
49.2	391.6
50.1	410.6
51.1	449.0
52.1	457.2
53.1	465.4
54.1	502.8
55.0	495.2
56.0	529.6
57.0	514.8
58.0	546.0
59.0	531.6
59.9	529.4
60.9	608.2
61.9	798.6
62.9	1086.4
63.8	1100.0
64.8	779.4
65.8	574.4
66.8	533.8
67.8	529.4
68.7	734.4
69.7	1514.0
70.7	2196.2
71.7	2016.8
72.6	1081.2
73.6	504.6

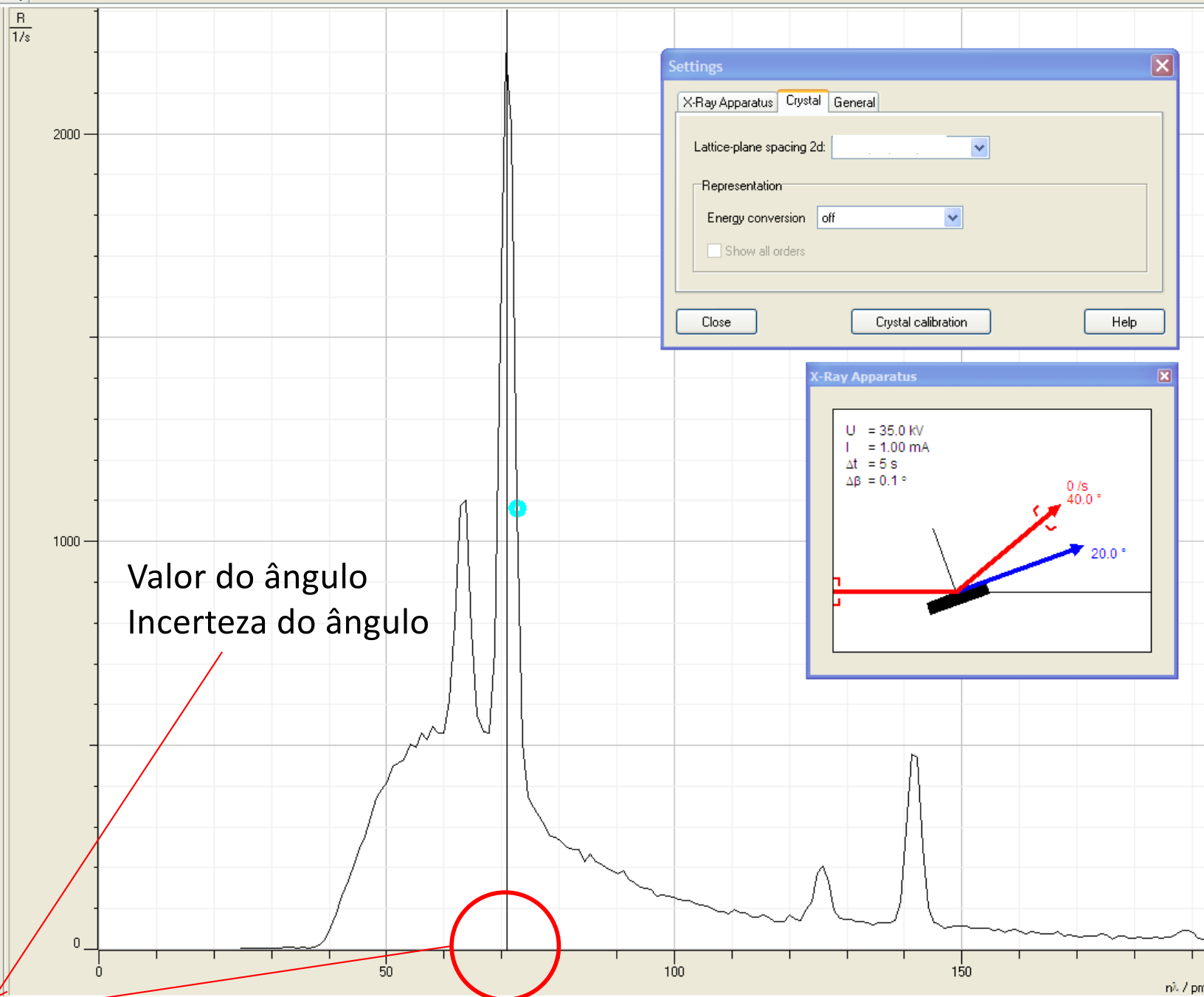

Valor do ângulo  
Incerteza do ângulo

Settings

X-Ray Apparatus Crystal General

Lattice-plane spacing 2d: [dropdown]

Representation

Energy conversion off [dropdown]

Show all orders

Close Crystal calibration Help

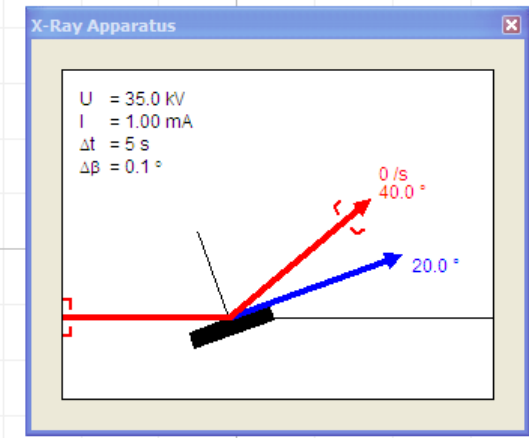

$n_i = 70.93$  pm,  $\sigma = 1.01$  pm



Figura 6 – Exibindo os pontos medidos

Bragg Planck Transmission Moseley

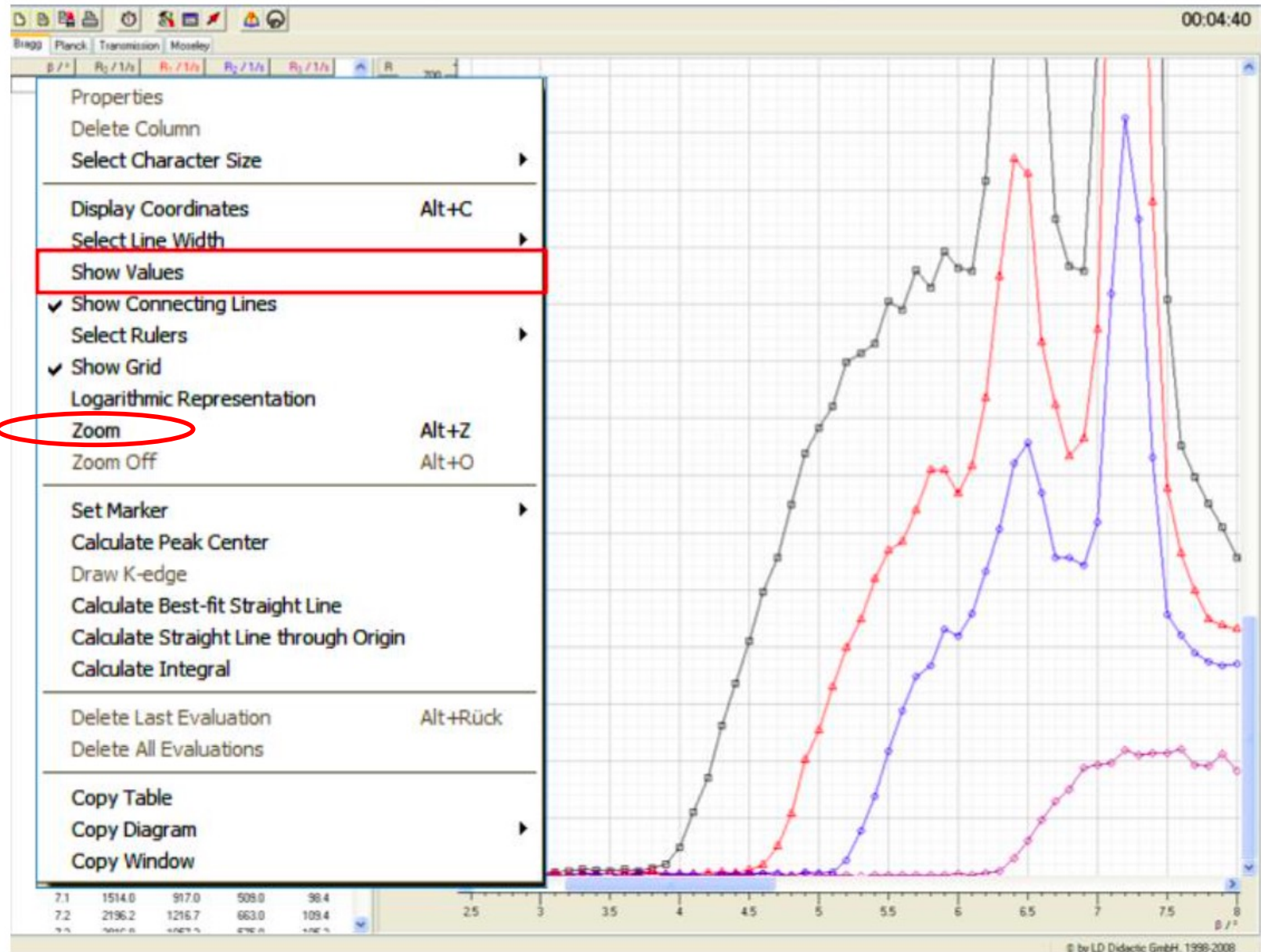
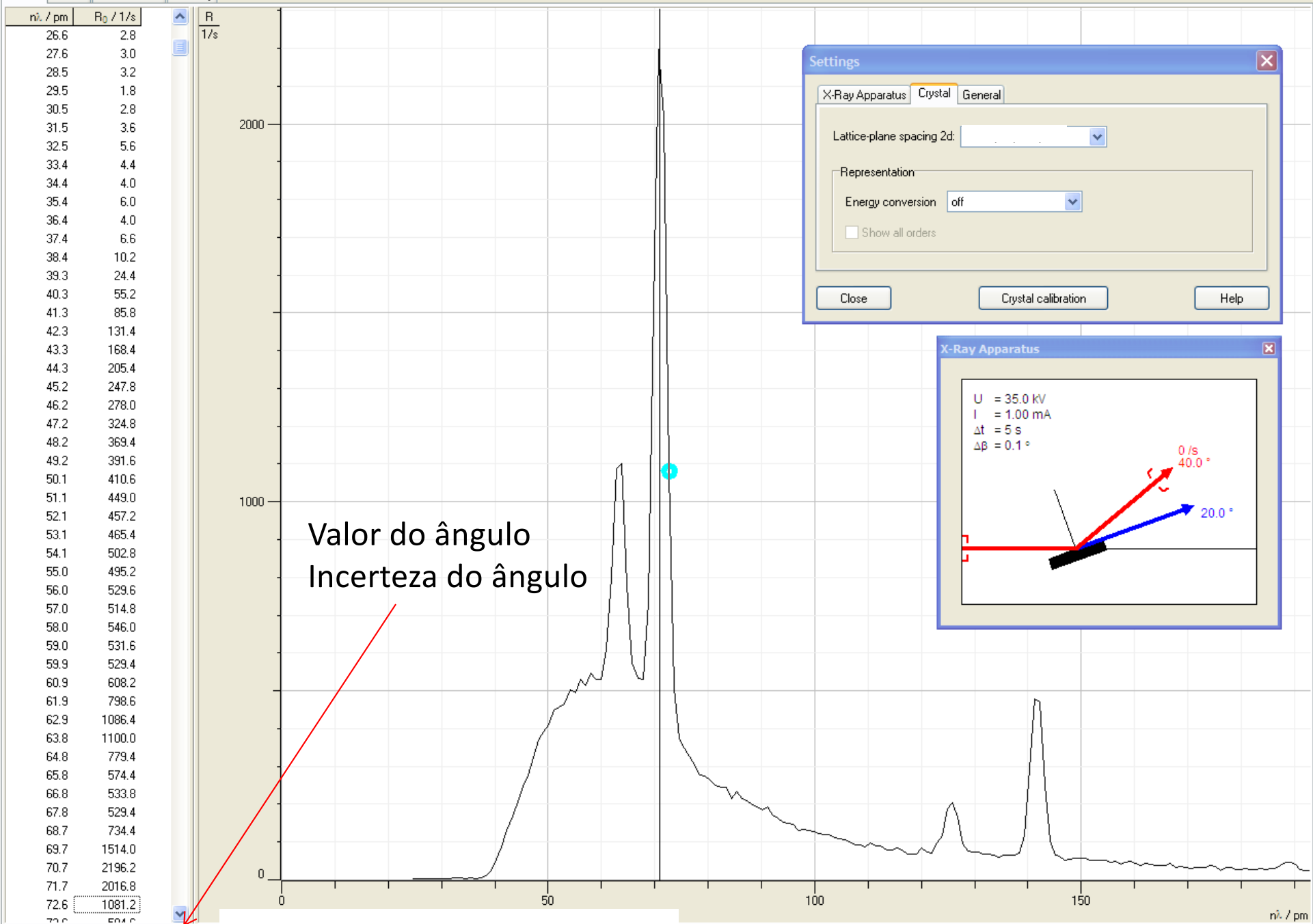

Settings

X-Ray Apparatus Crystal General

Lattice-plane spacing 2d: [dropdown]

Representation

Energy conversion off [dropdown]

Show all orders

Close Crystal calibration Help

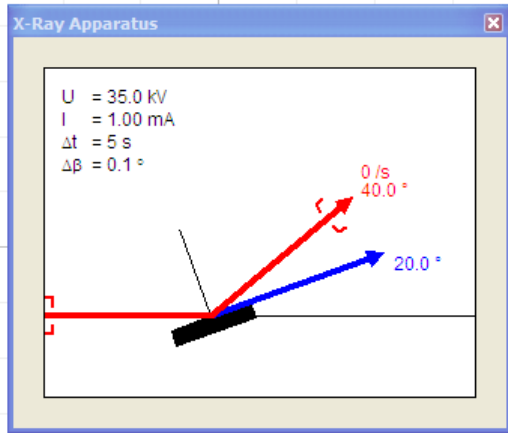

Valor do ângulo  
Incerteza do ângulo

Esses são os valores de  $\theta$  e  $\Delta\theta$

$\lambda = 70.93$  nm,  $\sigma = 1.01$  nm

## Valores dos comprimentos de onda das transições K do Mo

	$\frac{E}{\text{keV}}$	$\frac{\nu}{\text{EHz}}$	$\frac{\lambda}{\text{pm}}$
$K_{\alpha}$	17.443	4.2264	71.080
$K_{\beta}$	19.651	4.8287	63.095

$\text{keV} = 10^3 \text{ eV}$ ,  $\text{EHz} = 10^{18} \text{ Hz}$ ,  $\text{pm} = 10^{-12} \text{ m}$

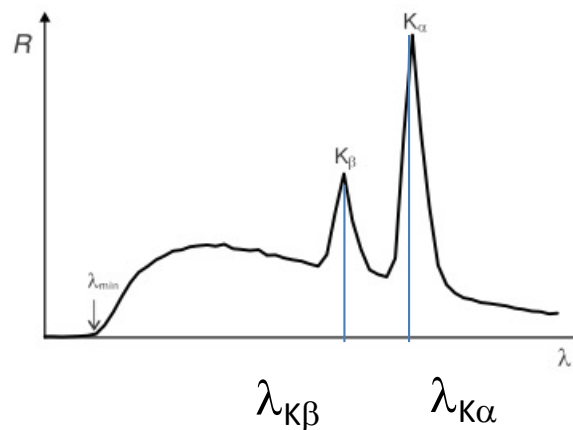



# Cálculos

- **Cálculo da distância interatômica  $d$**

- Para cada valor do ângulo  $\theta$  determinado (respectivamente, para  $K_\alpha$  e  $K_\beta$ ) pode ser calculado o valor de  $d$ , usando a lei de Bragg
  - Lei de Bragg:  $n\lambda = 2 \cdot d \sin(\theta)$

- Os *dois valores* de  $d$  precisam ser comparados

- Para isso, vai precisar das **incertezas** nos valores dos ângulos  $\theta$
- Elas *precisam ser propagadas* para os valores de  $d$
- Usar o método de propagação de intertezas apresentado no link

- [Propagação de erros](https://jkogler.wordpress.com/2008/03/18/hello-world/) <https://jkogler.wordpress.com/2008/03/18/hello-world/>

- Você tem de **deduzir a expressão** de  $\Delta d$  a partir da de  $\Delta \theta$

- Deve apresentar sua dedução em seu relatório

- De posse da formula que assim deduzir, poderá calcular os respectivos valores de  $d + \Delta d$

- **Cuidado: precisa converter a incerteza  $\Delta \theta$  para radianos !!**

Distância  
interatômica  $d$  (m)

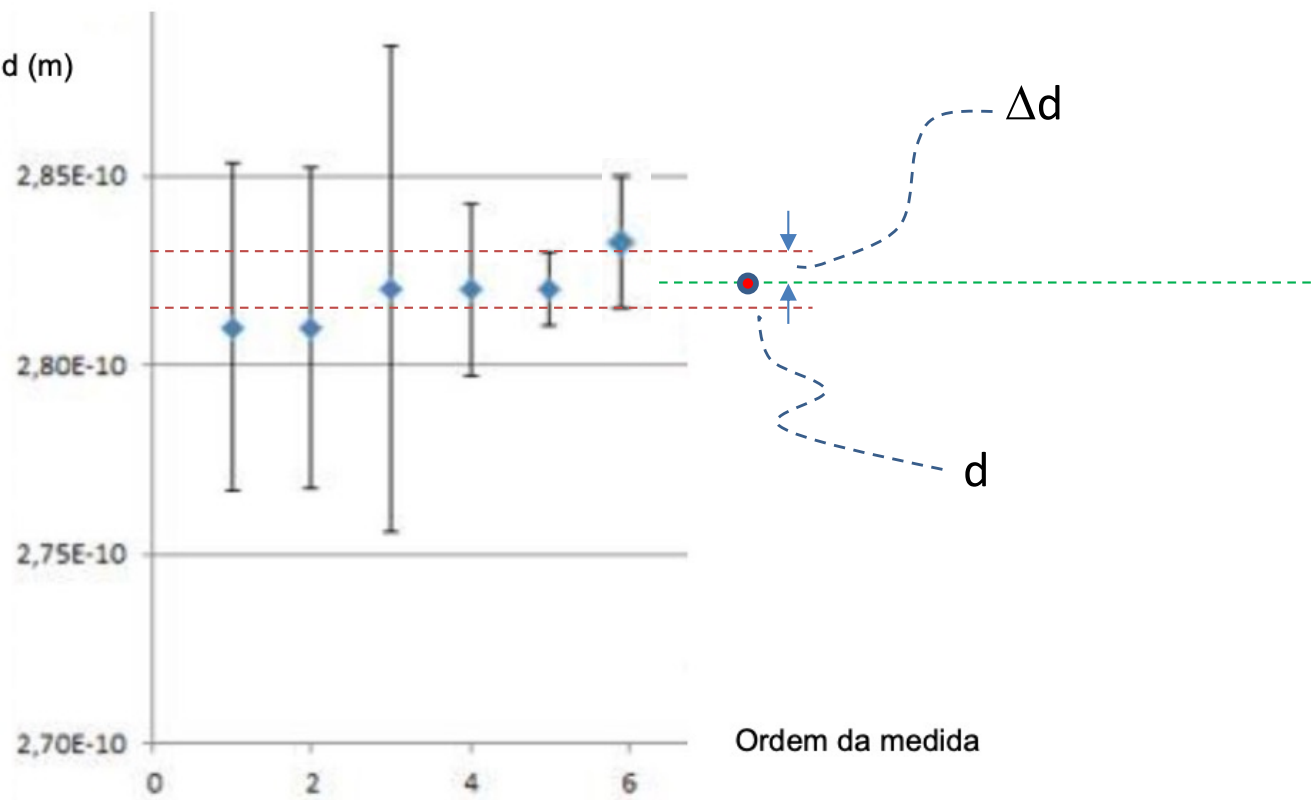

Após a tomada de dados, realizar as etapas de determinação dos ângulos  $\theta$  para os quais ocorrem os picos  $K_\alpha$  e  $K_\beta$ , com suas respectivas incertezas.

## Análises da difração de Bragg

1. Determinar os centros dos picos
2. Determinar as incertezas dos centros
3. Calcular os valores da distância interatômica  $d$  usando a lei de Bragg
4. Calcular os valores das incertezas  $\Delta d$  com a expressão que você deduziu

O cálculo do valor da distância interatômica  $d$  empregando a lei de Bragg

$$n\lambda = 2 \cdot d \sin(\theta)$$

para  $K_\alpha$  e  $K_\beta$ , usando

os respectivos valores de  $\theta$  encontrados para cada caso

podem ser feitos aqui no Lab

Os cálculos das incertezas em  $d$  podem ser feitos em casa

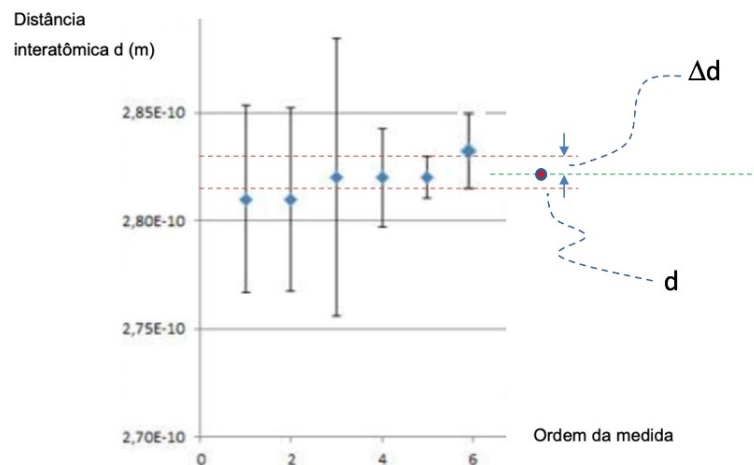

# Sumário da parte 1 da análise de dados

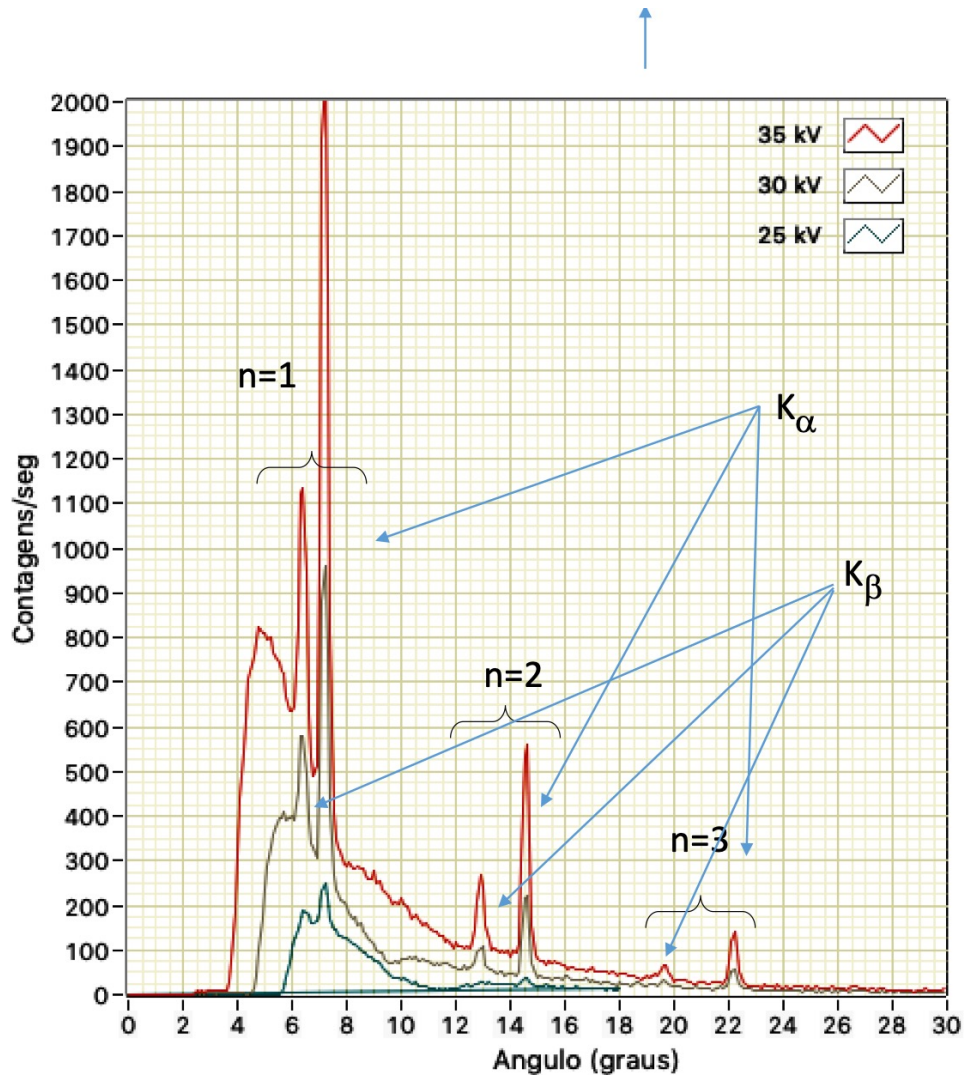

Obter picos e desvios para tensões de 35, 30 e 25 kV

Tensao: 35 kV	Pico: 22,20	Desvio: 0,20
Tensao: 30 kV	Pico: 22,16	Desvio: 0,18
Tensao: 25 kV	Pico: 22,16	Desvio: 0,16
Tensao: 30 kV	Pico: 6,46	Desvio: 0,24
Tensao: 30 kV	Pico: 7,19	Desvio: 0,16
Tensao: 35 kV	Pico: 12,90	Desvio: 0,22
Tensao: 35 kV	Pico: 14,56	Desvio: 0,16

$K_{\alpha}$ : Wavelength = 0.0711 nm

$K_{\beta}$ : Wavelength = 0.0632 nm

$\theta$   
graus

$\Delta\theta$   
graus

radianos

Roteiro de Análise

Deduzir fórmula de  $\Delta d$  a partir de  $\Delta\theta$

<https://jkogler.wordpress.com/2008/03/18/hello-world/>

Para cada pico  
Calcular d:  
 $d = n \lambda / 2 \sin(\theta)$

Para cada pico:  
calcular  $\Delta d$  a partir de  $\Delta\theta$

Resultado: 12 a 18 valores de  $d \pm \Delta d$

Intersecção dos 12 a 18 intervalos

**Resultado final de  $d \pm \Delta d$**

# Análise dos dados

Feita com auxílio do programa  
X ray apparatus

## Parte 2 - Determinação da constante de Planck

1. Determinar os  $\lambda_c$  de corte
2. Fazer o gráfico de U em função de  $1/\lambda_c$
3. Determinar o coeficiente da regressão linear
  4. Calcular a constante de Planck
  5. Comparar com o valor conhecido



Figura 5 – Curvas de espectro de bremsstrahlung



Figura 6 – Exibindo os pontos medidos

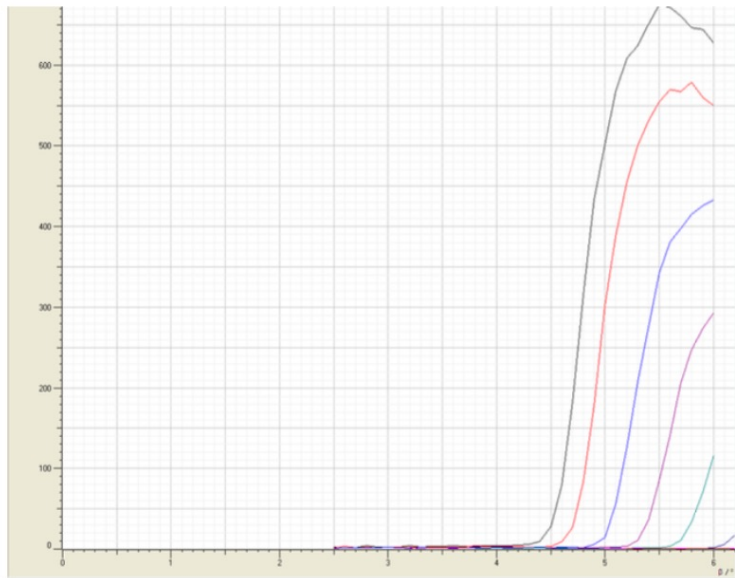

Voltar à configuração para Planck

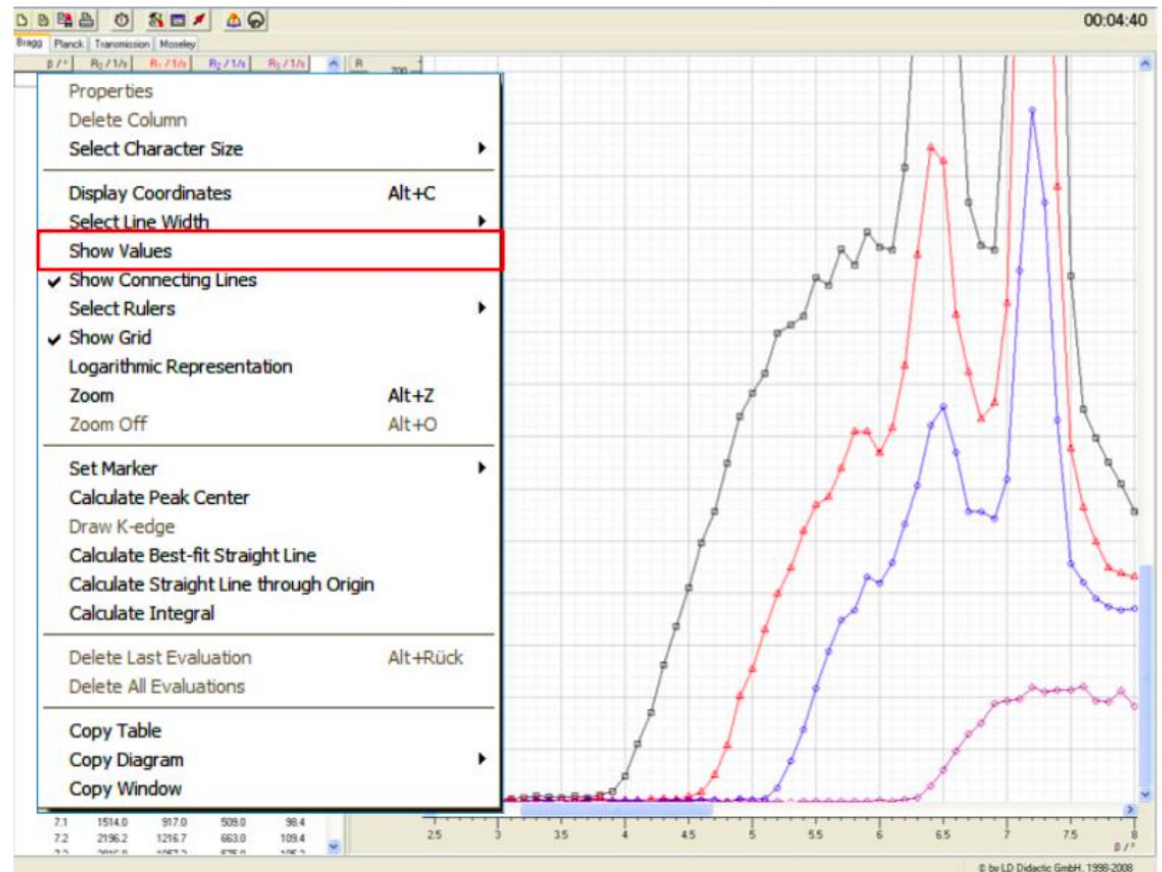
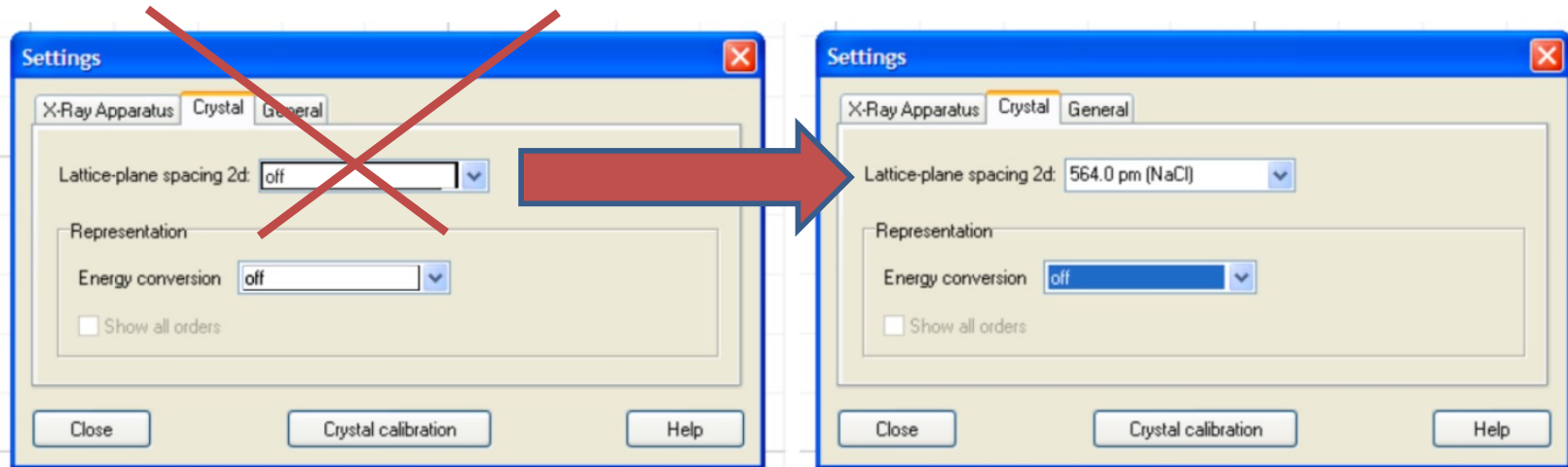

(a)

(b)

Configurações do painel *Settings* para cada experimento. (a) Configuração usada no primeiro experimento (difração de Bragg). As duas caixas devem ficar em off. (b) Configuração usada no segundo experimento (determinação de  $h$ ). Informar o valor de  $d$  na caixa de cima e a outra deixar em off.



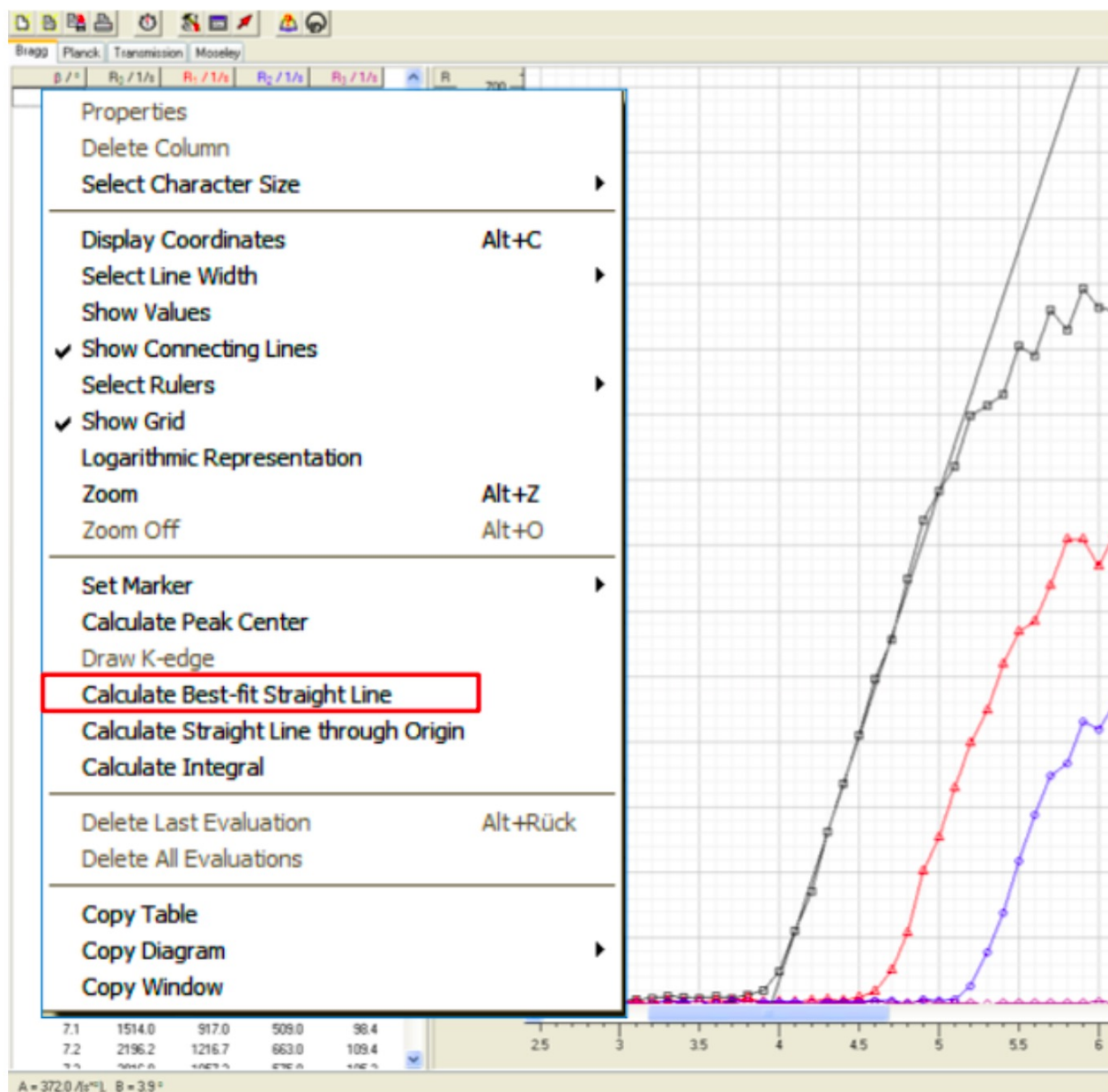

Para cada curva, deverá ajustar por regressão linear uma reta que modela aproximadamente a subida do espectro de bremsstrahlung para valores de comprimento de onda próximos ao corte. Isso é feito selecionando-se no menu com clique-direito a opção Calculate best-fit straight line, conforme mostrado na figura ao lado

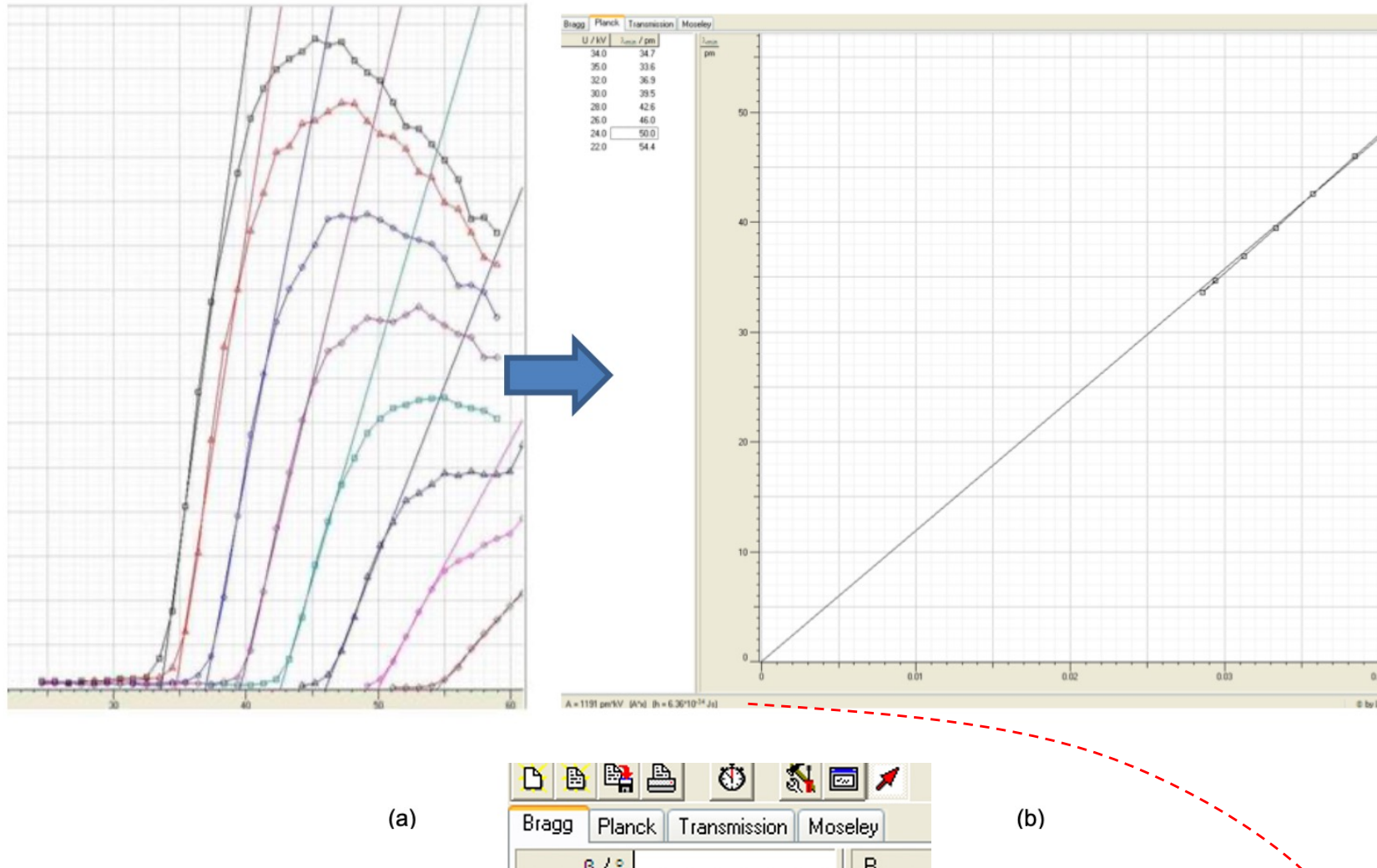

Ao terminar o procedimento para todas curvas de Bremsstrahlung, conforme mostrado na fig. a, **clique na aba Planck** e observará que todos os valores de frequência de corte e das correspondentes tensões de aceleração já foram transferidos (fig. b) para o programa que ajusta a relação de Duane-Hunt e fornece o valor do coeficiente angular da reta, com o qual poderá calcular a constante de Planck e comparar com valores tabelados.

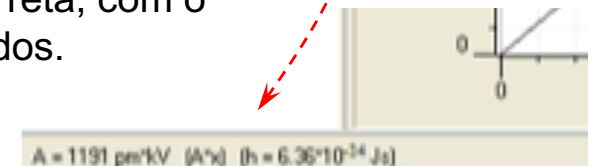

## Sumário da parte 2 da análise de dados

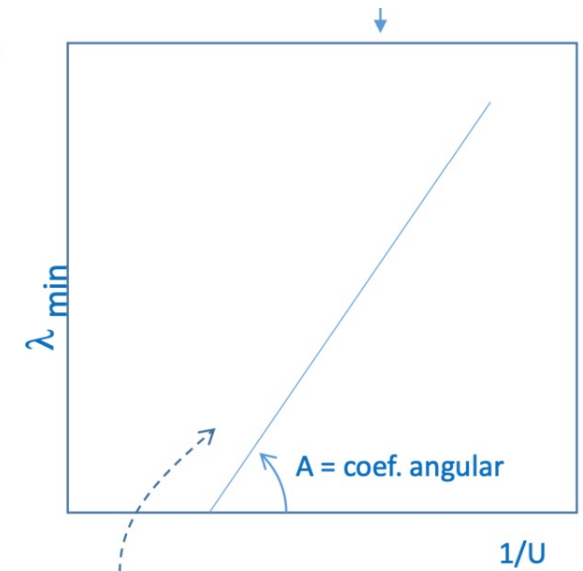
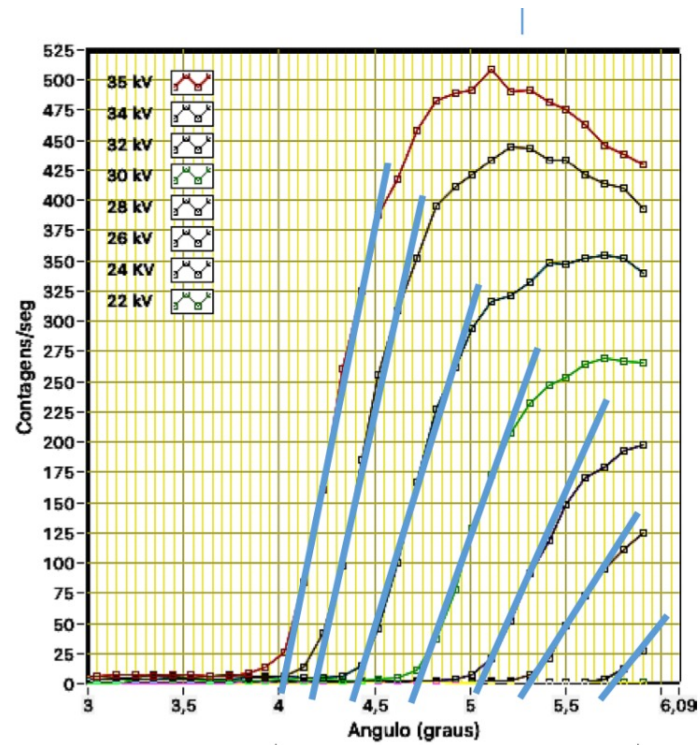
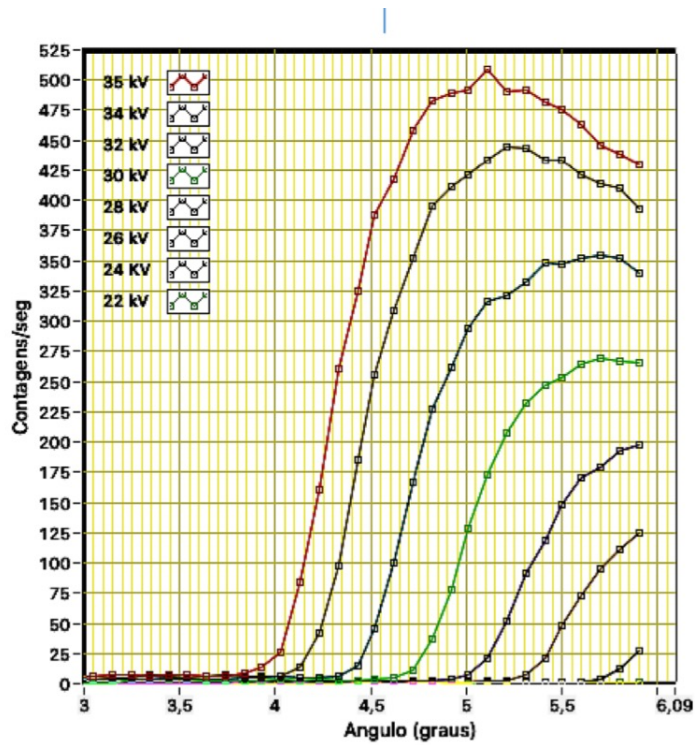

Lei de Duane Hunt

Calcular constante de Planck

$\lambda_{\min}$

$1/U$





*Quaisquer dúvidas,  
perguntem! Boa sorte!*

Universidade de São Paulo  
Instituto de Física  
Laboratório de Física Moderna

Disciplina: Física Experimental C - 4323301  
Coordenador: José Helder Facundo Severo

Experimento: Difração de Raio-X  
Edição 2020 – EAD

Autor: João Eduardo Kogler Jr.  
Escola Politécnica da USP  
Departamento de Sistemas Eletrônicos  
[kogler@lsi.usp.br](mailto:kogler@lsi.usp.br)

Apresentação– versão 2023 Semestral